



DCN 1000 and Twin 1000

DOC 022

User's manual

HGH Systèmes Infrarouges

10, rue Maryse Bastié
91430 IGNU
FRANCE

www.hgh-infrared.com
hgh@hgh-infrared.com

Tél. : +33 1 69 35 47 70
Fax : +33 1 69 35 47 80



Enlighten the Unseen

Revision

Revision	Written Name - Signature	Approved Name - Signature
I1	X Catherine Barrat	X Grégory Gitzinger

History of the revisions

Revision	Description	Date
A1	Document creation	19/07/2013
B1	INFRATEST - LT replaces Pilot CN	30/01/2014
C1	Ajout de l'adresse IP CN	13/02/2014
D1	Nouveau coffret sans alimentation externe – modification tête	22/04/2014
E1	Manuel unique DCN	16/06/2016
F1	Controller modification	16/07/2018
F2	Correction tableau paragraphe 6.1.2.	08/10/2019
G1	Rajout de la mention garder les emballages et la description du caisson d'azotage	04/11/2019
H1	Ajout Twin1000 + gestion double tête	22/04/2020
I1	Vidange chiller, compensation radiométrique, opération LT	12/01/2024
J1	Ajout mode différentiel A vs. B double tête	23/12/2024
K1	Changement logo	xx/xx/xxxx



1. GENERAL PRESENTATION	6
1.1. INTRODUCTION	6
1.2. FEATURES	9
1.2.1. DCN 1000	9
1.2.2. TwiN 1000.....	9
2. DESCRIPTION	10
2.1. ELECTRONIC CONTROLLER	12
2.2. DCN 1000 – BLACKBODY HEAD	13
2.3. TWIN 1000 – BLACKBODY HEAD	16
2.4. THERMOSTAT (FOR DCN 1000 L ONLY)	18
2.4.1. Lauda Thermostat.....	18
2.4.2. Julabo Thermostat	20
2.5. TEST TARGETS (option for DCN1000 only)	22
2.6. ANTI-CONDENSATION/ FROST SYSTEMS (option for DCN1000 only)	24
2.6.1. Set of sleeves	24
2.6.2. Dry box with sleeves (DCN1000 N7/12 and L7/12 only)	25
2.7. AIR DEFLECTORS (N7 and N12 only)	26
2.8. SUPPLY	26
2.9. OPTIONAL SUPPLIES	27
2.9.1. Target support (DCN1000 only).....	27
2.9.2. Test targets (DCN1000 only).....	27
2.9.3. Anti-condensation / Frost system (DCN1000 only)	27
2.9.4. Additional head (DCN1000 size 2 to 4 only).....	28
2.9.5. LabView drivers and/or SDK license	28
3. OPERATION	29
3.1. PREPARATION OF THE BLACKBODY	29
3.2. PREPARATION OF THE THERMOSTAT (DCN 1000 L ONLY)	31
3.2.1. Important remark regarding the temperature range of the DCN1000L blackbodies	31
3.2.2. Fluid properties	31
3.2.3. Getting started	32
3.2.4. Starting the fluid temperature control.....	32
3.2.5. Important remarks for thermostat operation	32
3.2.6. Thermostat and fluid upkeep procedures	33
3.3. USE OF THE ANTI CONDENSATION /FROST SYSTEMS (DCN1000 only)	33
3.3.1. Desiccant activation	33
3.3.2. Use of the set of sleeves (DCN1000 only)	34
3.3.3. Use of the dry box with sleeves (DCN1000 only).....	35
3.4. CONDENSATE WATER REMOVAL (DCN1000 only)	35
3.5. PREPARATION OF THE TARGET AND TARGET SUPPORT (DCN1000 only)	36



3.6. USER INTERFACE.....	36
3.6.1. Starting procedure	36
3.6.2. DCN 1000 – Main screen	36
3.6.3. TwiN1000 – Main screen	38
3.6.4. Numeric keypads	39
3.6.5. Target selection menu	40
3.6.6. Predefined set-points.....	40
3.6.7. Advanced menu	41
3.7. DCN 1000 LT (OPTION).....	49
3.7.1. Special recommendations for operation	49
3.7.2. Blackbody temperature achievable range	49
4. REMOTE CONTROL.....	51
4.1. ETHERNET INTERFACE	51
4.2. RS232C INTERFACE	51
4.3. IEEE488 INTERFACE	51
4.4. LABVIEW DRIVERS (OPTION)	51
4.5. SDK LICENSE (OPTION).....	52
5. PRECAUTIONS OF USE AND MAINTENANCE	53
5.1. ELECTRONIC CONTROLLER.....	53
5.2. BLACKBODY HEAD	53
5.3. COOLING FLUID.....	53
5.4. TEST TARGETS AND TARGET WHEEL (options)	54
5.5. TROUBLE SHOOTING.....	54
5.5.1. The main button remains off	54
5.5.2. Autotest.....	54
5.5.3. The fans don't work.....	55
5.5.4. Inactive touchscreen	55
5.5.5. Limited temperature range.....	56
5.5.6. The blackbody is unstable	56
5.5.7. The thermostat displays an alarm message	56
5.5.8. Blackbody shut down recommendations	57
6. MAIN CHARACTERISTICS	58
6.1. CONDITIONS OF USE	58
6.1.1. Electronic controller	58
6.1.2. Blackbody head	59
6.1.3. Thermostat (DCN 1000 type L only).....	59
6.2. MAIN SPECIFICATIONS.....	59
6.2.1. Mechanical characteristics.....	59
6.2.2. Test targets (options for DCN1000 only)	60



7. APPENDIX 162



1. GENERAL PRESENTATION

1.1. INTRODUCTION

Thanks to different optical systems (cameras, scanners, radiometers, thermal imaging systems...), infrared thermography allows the measurement of the emitted power of an object and possibly its temperature.

The reference IR sources DCN1000 and TwiN1000 allow the characterization or the calibration of these optical systems.

The DCN1000 is a reference blackbody with a square emitting surface which temperature is accurately regulated over a wide temperature range.

The TwiN1000 is a reference blackbody with two square emitting surfaces. Each temperature surface can be accurately and separately regulated over a wide temperature range.

As every HGHI's blackbody, it provides an emissive surface with superior uniformity. Its highly stable radiometric structure makes it a reliable IR reference source delivered with a certificate of calibration valid for 2 years.



Figure 1: Left: DCN 1000 N7 head (with optional target holder) / Right: DCN 1000 N12 head equipped with deflectors

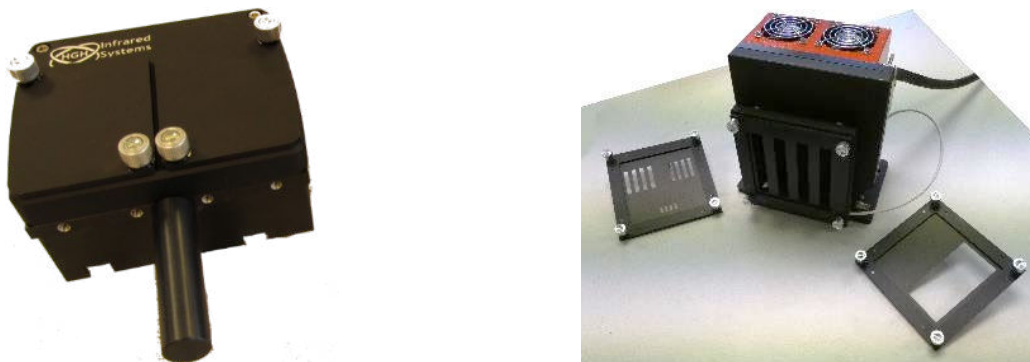

Figure 2: Left: Twin 1000 CN / Right: DCN 1000 H4 with optional target holder and targets



The reference name of the blackbody corresponds to

- Cooling method: liquid, fan or natural
- Surface size in inches (approx.)

Table 1 shows the list of available DCN1000 models.

	Emissive surface size	Type of cooling	Temperature range***
DCN 1000 H2	50 mm x 50 mm	Fans	[-15°C; 150°C]*
DCN 1000 W2L	50 mm x 50 mm	Liquid or fresh water	[-20°C; 100°C]
DCN 1000 H3	75 mm x 75 mm	Fans	[-15°C; 150°C]
DCN 1000 H4	100 mm x 100 mm	Fans	[-15°C; 150°C]*
DCN 1000 L4	100 mm x 100 mm	Liquid (with thermostat)	[-40°C; 150°C]
DCN 1000 N7	180 mm x 180 mm	Fans	[-5°C; 150°C]**
DCN 1000 L7	180 mm x 180 mm	Liquid (with thermostat)	[-40°C; 150°C]
DCN 1000 N12	300 mm x 300mm	Fans	[-5°C; 150°C]
DCN 1000 L12	300 mm x 300mm	Liquid (with thermostat)	[-40°C; 150°C]
Twin 1000 CN	2 * 42 mm x 42 mm	Natural	[10°C; 90°C]
Twin 1000 CF	2 * 42 mm x 42 mm	Fan	[-5°C; 150°C]

Table 1: List of available DCN1000 and Twin1000 models

* [-15°C; 200°C] in option.

** [-15°C; 180°C] in option.

*** for 20°C ± 5°C ambient temperature

The DCN 1000 is also able to regulate the temperature of its emissive surface with respect to the temperature of a sensor measuring the temperature of an interchangeable test target (generally at room temperature). This sensor is located either on a target support assembled to the front plate of the blackbody head or into a target wheel. This operating mode is called **differential mode**.

Associated to higher level INFRATEST software and to IRCOL collimators (in the case of scenes simulated at the infinity), the DCN 1000 and Twin1000 allows performing all the IR tests and calibrations for thermal imagers:

- Thermal calibration
- Temporal noise
- Fixed pattern noise
- NETD (Noise Equivalent Temperature Difference)
- SiTF (Signal Transfer Function)
- Temporal noise power spectral density
- Spatial noise power spectral density



And with DCN1000 only:

- Field of view
- Line spread function
- Modulation transfer function
- Distortion
- MRTD (Minimum Resolvable Temperature difference)
- TOD (Triangle Orientation Discrimination)
- Detection, Recognition and Identification ranges.



1.2. FEATURES

1.2.1. DCN 1000

- ✓ High emissivity,
- ✓ High display resolution to 1/10 mK for temperature measurements and set point in absolute and differential mode,
- ✓ Incomparable regulation stability down to 0.5 mK,
- ✓ High uniformity,
- ✓ High speed heating and **cooling** down,
- ✓ Very wide temperature range,
- ✓ Supplied with International Primary Standards traceable radiometric calibration certificates over MWIR and LWIR ranges certificate valid for 2 years,
- ✓ User selectable display of physical temperature or radiometric temperature,
- ✓ Remote control through Ethernet, IEEE488 or RS232 communication links,
- ✓ Delivered with ready-to-use remote control software Infratest-LT,
- ✓ Exclusive drivers for LabVIEW for all communication types.

1.2.2. TwiN 1000

- ✓ Two separated emitting area included in a one compact mechanical product,
- ✓ One controller to control two emitting surfaces,
- ✓ Other features: same as DCN1000, please refer above.

2. DESCRIPTION

The system consists in four different main sub-assemblies:

- The Electronic Controller
- The Blackbody Head
- The IR Target (option)
- The Thermostat (DCN1000L only)

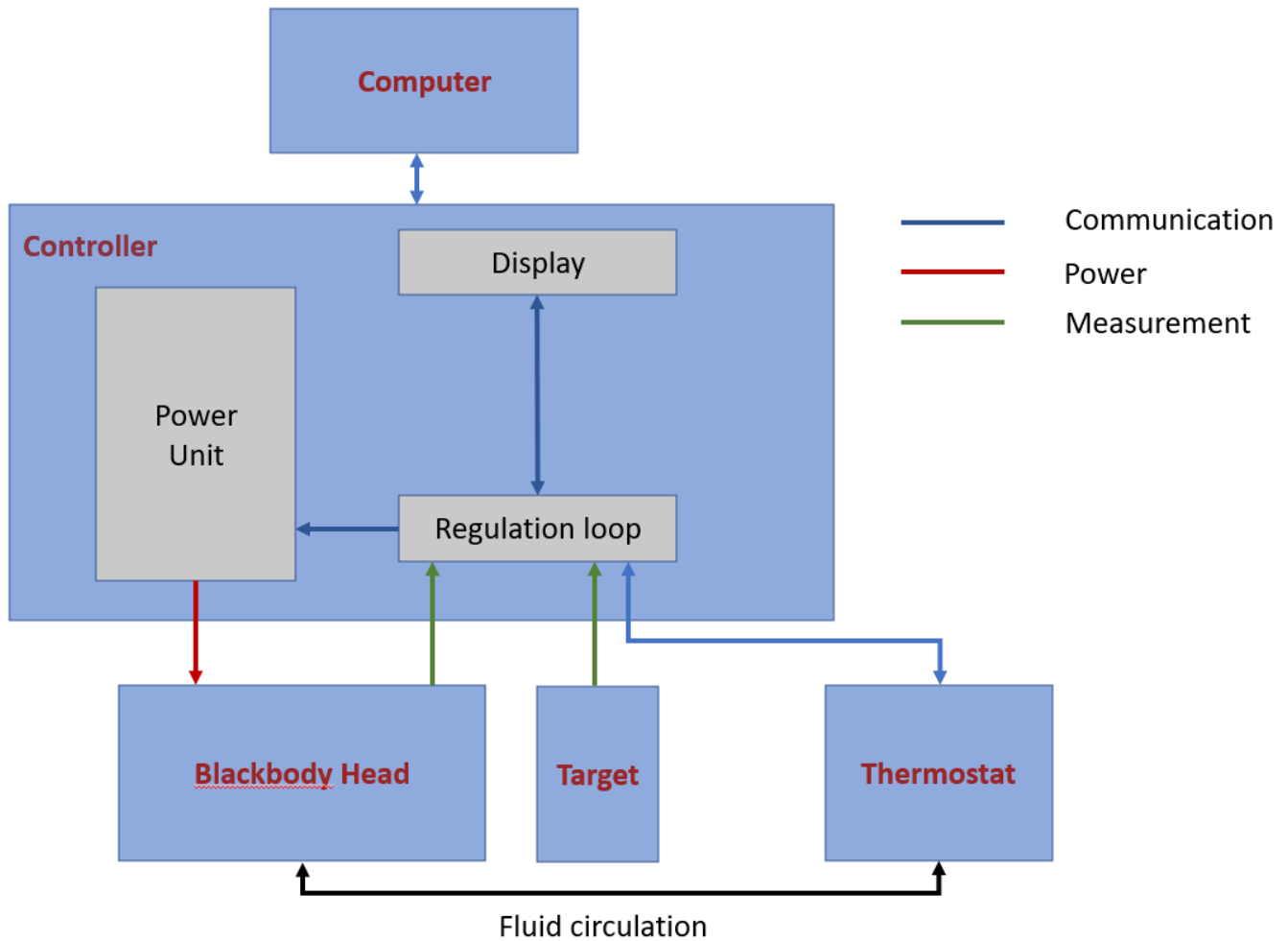
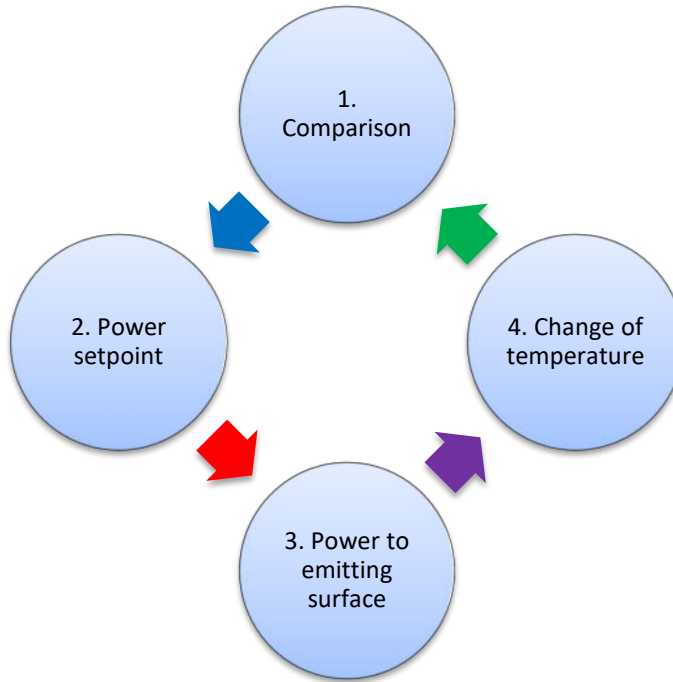

Figure 3: Synoptic scheme

The principle of operation of the DCN1000 and TwiN1000 is based on the temperature regulation loop:

1. Comparison of the actual temperature of the surface with the temperature setpoint. The temperature of the surface is measured by the **sensor** inserted into the emitting surface.
2. Conversion of the comparison result into **power setpoint**
3. **Application of the power** to the emitting surface (heating or cooling)
4. **Modification** of the emitting surface temperature





2.1. ELECTRONIC CONTROLLER

The electronic controller processes the output data of the temperature sensors and controls the Power Unit through a dedicated communication link. Then the Electronic Controller sends the power to the Blackbody Head in order to regulate its temperature at the desired set-point in differential or in absolute mode.

By default, the controller is configured to control one blackbody head. In option, the controller can be configured to control two heads of the same size at the same time (size 2 and 4 only).



Figure 4: Electronic Controller front panel

The front panel entails:

- a main button,
- a touchscreen.

The main button allows switching ON or OFF the controller. In user mode, the ambient temperature, the blackbody absolute temperature or the differential temperature are displayed on the screen in real time.

The mains button is lighted when the power switch at the rear panel is ON.

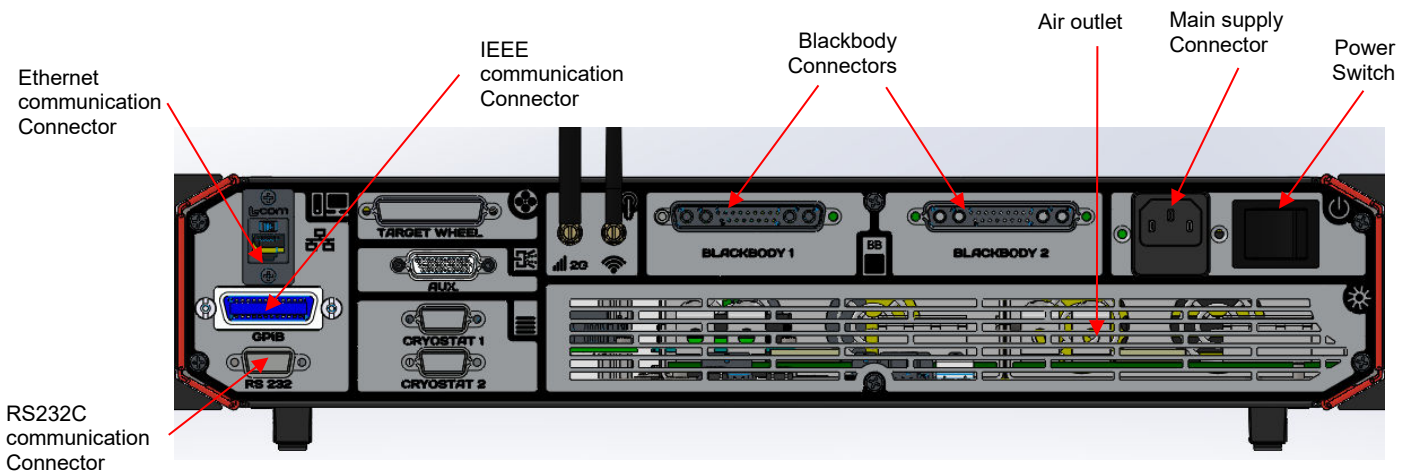

Figure 5: Electronic Controller rear panel

The Mains Supply connector, the power switch, Blackbody Connectors and the communication connectors are located on the rear panel.

The Power Switch allows the voltage supply of the controller.

The electronic controller is also rackable in an electrical cabinet:



Figure 6: Blackbody controllers integrated inside an electrical cabinet

Four M6x16 screws are needed to assemble a controller in the cabinet.

2 retractable feet are also available underneath the controller when put on a table to raise the screen of the cabinet:



Retractable feet

For cabinet & table

2.2. DCN 1000 – BLACKBODY HEAD

The blackbody head of the DCN 1000 entails a temperature-controlled emitting dark surface.



Figure 7: DCN 1000 head (front view)



Figure 8: DCN 1000 head (rear view)

The temperature of the emissive surface is measured with a high precision thermometric platinum sensor.

A set of thermoelectric elements using Peltier effect allows controlling the temperature of the blackbody.

Fans or liquid circulation cool down the hot face of the thermoelectric elements at ambient temperature to increase the efficiency and the working temperature range.

The blackbody head is connected to the electronic controller using the “BLACKBODY” connector.

The Sub-D 9 contacts “TARGET SENSOR” connector allows connecting the temperature sensor of an external target for the differential operating mode. This sensor can be inserted into:

- a remote target wheel,
- the optional target support assembled to the front of the blackbody.



In case of absolute operating mode (i.e. no target), a dedicated electronic cap (labelled Tamb cap) with its own temperature sensor is set. This cap entails a sensor which measures the ambient temperature.



Figure 9: Blackbody head connectors

When the blackbody head is not in use, it is preferable to set its cover using the four latches:



Figure 10: Blackbody Head cover



2.3. TWIN 1000 – BLACKBODY HEAD

The blackbody head of the TwiN1000 entails two temperature-controlled emitting dark surfaces

The blackbody has two different configurations:

- Natural convection: there is no fan to cool the blackbody. This configuration is supplied with a handle. The blackbody connector is on the back of the head,
- Forced convection: a fan cools down the hot face of the thermoelectric elements at ambient temperature to increase the efficiency and the working temperature range. A cover has been added. The blackbody connector is on the side.

The temperature of each emissive surface is measured with a high precision thermometric platinum sensor.

A set of thermoelectric elements using Peltier effect allows controlling the temperature of each surface.

When the blackbody head is not in use, it is preferable to set its covers (see Figure 2).

Important remark: the optimize operation of the TwiN1000 is achieved when the temperatures of the two emissive surfaces are different. Consequently, it is not recommended to set the temperature of the two surfaces at the minimum value simultaneously.



Natural convection

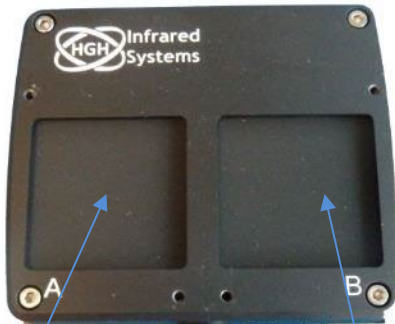

Emissive area for blackbody A or 1

Emissive area for blackbody B or 2

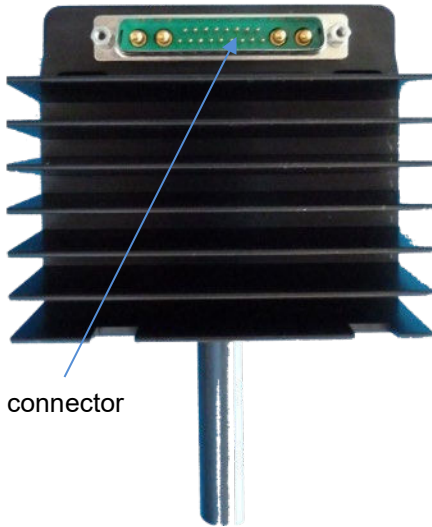

Blackbody connector

Forced convection

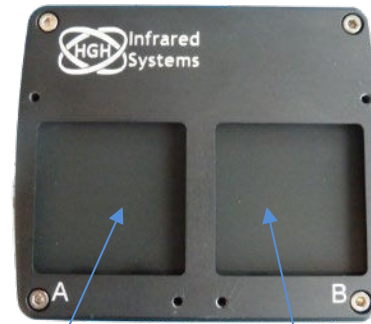

Emissive area for blackbody A or 1

Emissive area for blackbody B or 2



Air inlet

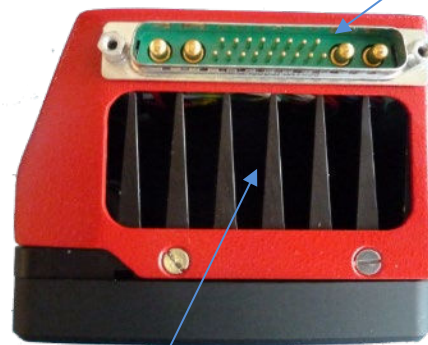

Blackbody connector

Air outlet

2.4. THERMOSTAT (FOR DCN 1000 L ONLY)

The thermostat controls the temperature of a circulating fluid going through the blackbody head. This enables to increase the range of temperature of the emissive surface, especially at low temperatures.

The thermostat is remotely controlled through the controller (refer to paragraph 3.6.7.6).

2 types of thermostats can be supplied with these models of blackbodies:

2.4.1. Lauda Thermostat



Figure 11: Lauda Thermostat front view

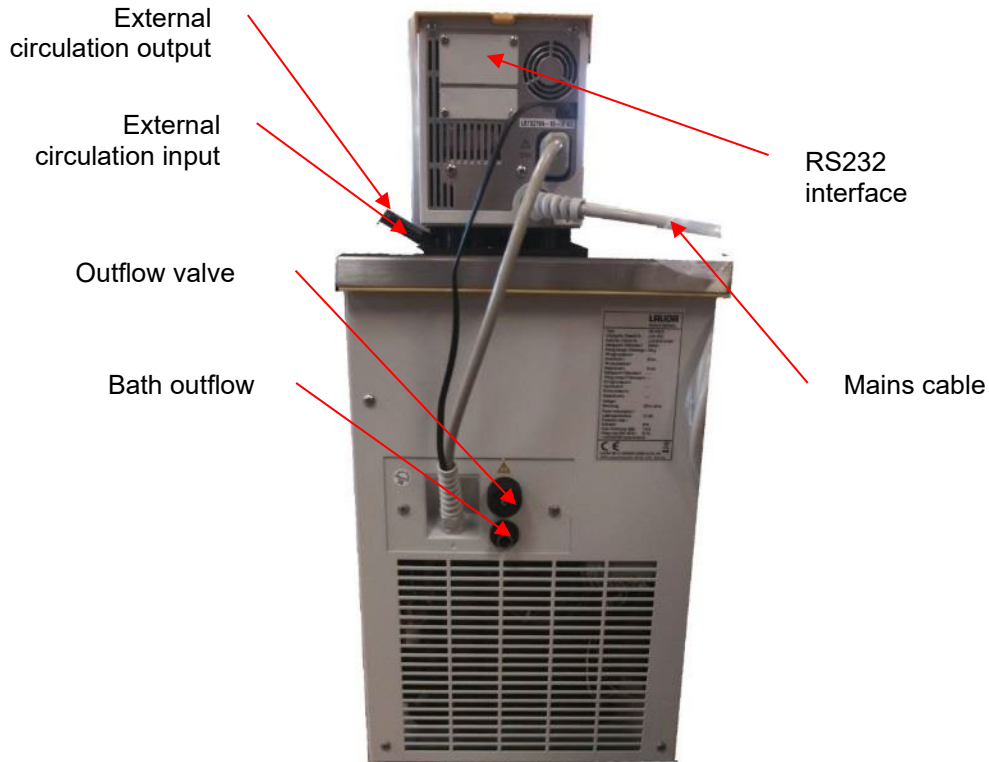

Figure 12: Lauda Thermostat rear view

The thermostat entails a fluid tank accessible from its top, lifting the cover with the grey handle.

This fluid volume can be either heated with electric resistors or cooled with a compressor and a thermal exchanger.

A pump makes a circulation of the fluid through the blackbody heat exchanger, using external pipes.



Figure 13: Lauda Thermostat top view

The user interface is the following:

- 0/1 button: in order to switch On or Off the thermostat,
- The display screen: it displays the current measured temperature.

2.4.2. Julabo Thermostat

User's interface



Thermal fluid tank



Outflow valve and bath

Figure 14: Julabo Thermostat front view (with and without cover)



RS232
interface

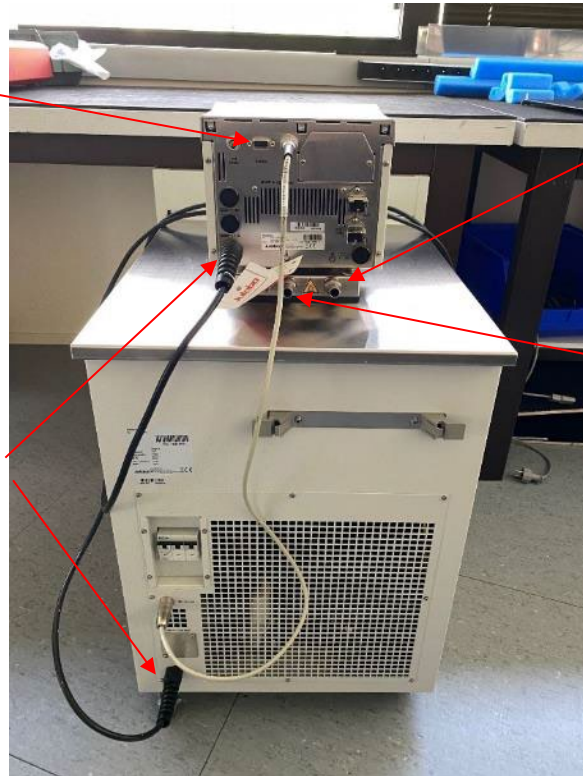

External
circulation input

External
circulation output

Power cords

Figure 15: Julabo Thermostat back view

The thermostat entails a fluid tank accessible from its top, lifting the cover with the green handle.

This fluid volume can be either heated with electric resistors or cooled with a compressor and a thermal exchanger.

A pump makes a circulation of the fluid through the blackbody heat exchanger, using external pipes.

2.5. TEST TARGETS (option for DCN1000 only)

Remark: this item is not compatible with the anti-condensation sleeves option.

The test targets are assembled to the target support, itself being assembled to the blackbody head front panel through a set of 4 M4 screws and spacers. Both the target support and targets are optional to the DCN1000.

The target support consists in a mechanical support for targets and an integrated sensor connected to a SUB-D 9 connector. For correct differential mode operation, this connector must be connected to the blackbody head and replaces the Tamb cap (see paragraph 2.2).

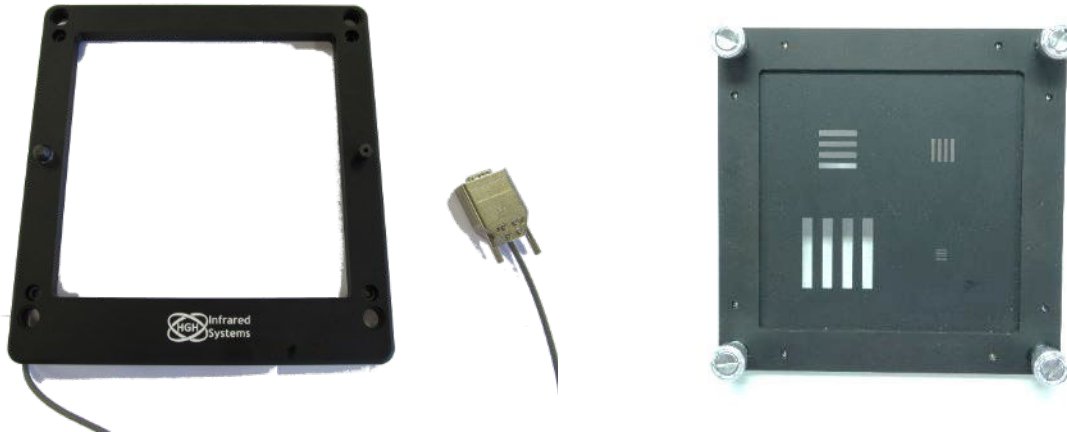

Figure 16 : target support and target

A set of different test targets can also be provided with their mechanical mount.

A catalogue of standard targets can be disclosed on request.

This catalogue entails:

- 4 bar patterns (for MRTD),
- Square patterns (for MDTD),
- Half disk or knife edge patterns (for LSF/MTF),
- Slot patterns (for LSF/MTF),
- Pin hole patterns (for PSF or NETD),
- Pin holes grids (for distortion).

Specific targets can also be easily designed and manufactured on request.

The test target is fixed in front of the target support using the 4 screws.

Hereafter is a view of a blackbody system when a target is assembled on the target support:



Figure 17 : DCN 1000 H4 blackbody with mounted MRTD target

When unmounting the target, it is advised not to touch and check that there is nothing in contact with the black painted surface of the target.

2.6. ANTI-CONDENSATION/ FROST SYSTEMS (option for DCN1000 only)

Remark: these systems are not compatible with the target support option.

2.6.1. Set of sleeves

The minimum absolute temperature of DCN 1000 may be much lower than the dew point temperature. In this case, condensation or freeze may appear on the emissive surface.

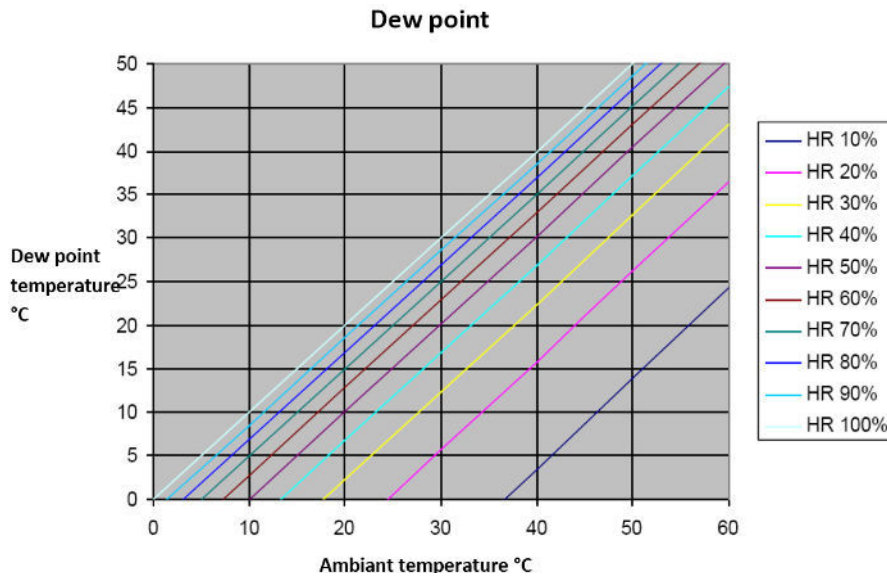

Figure 18: Dew point as a function of the ambient temperature and the Blackbody temperature

To prevent this phenomenon, anti-condensation sleeves may be ordered as option on request.

The system consists in different components:

- A mechanical adaptor (This part is fixed in front of the blackbody),
- A set of sleeves. The sleeves are fixed in front of the mechanical adaptor. The size of the sleeves depends on the lens diameter of the unit under test. The lens is fixed on the other side of the sleeve,
- Desiccant box (hydrophilic granulates). It is required to put some desiccant in the mechanical adaptor during the use of the sleeves, in order to catch the remaining humidity.

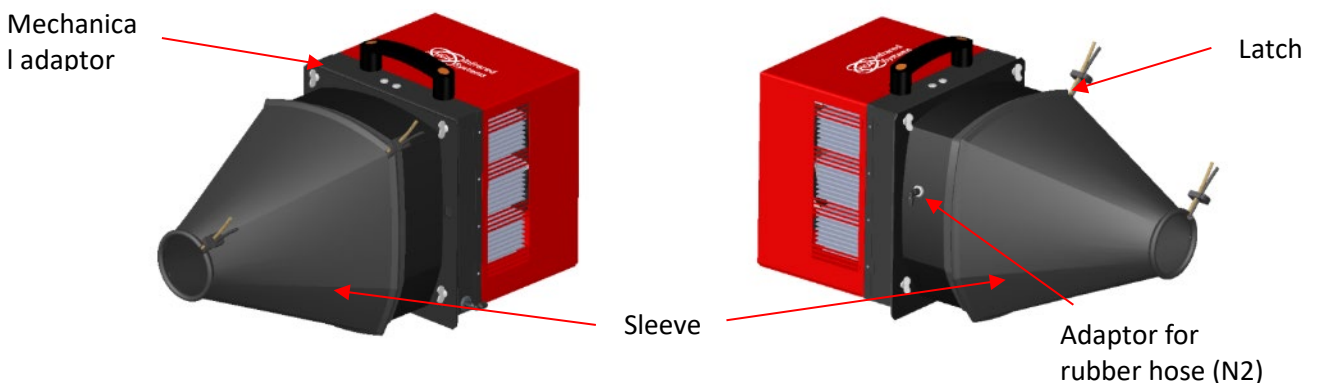

Figure 19: anti-condensation sleeves on a DCN 1000 N12



Important remark: thanks to optimized selection of DCN1000 emissive paint by HGH, eventual water or ice condensation does not damage the emissive surface. In case of water or ice condensation, just select temperature above dew point to remove it. However, make sure that water or ice does not remain on the emissive surface for a long time and too frequently.

2.6.2. Dry box with sleeves (DCN1000 N7/12 and L7/12 only)

To prevent the phenomenon of condensation or freeze, A dry box with sleeves may be ordered as option on request (DCN 1000 N12, DCN 1000 L12, DCN 1000 N7 and DCN 1000 L7 only).

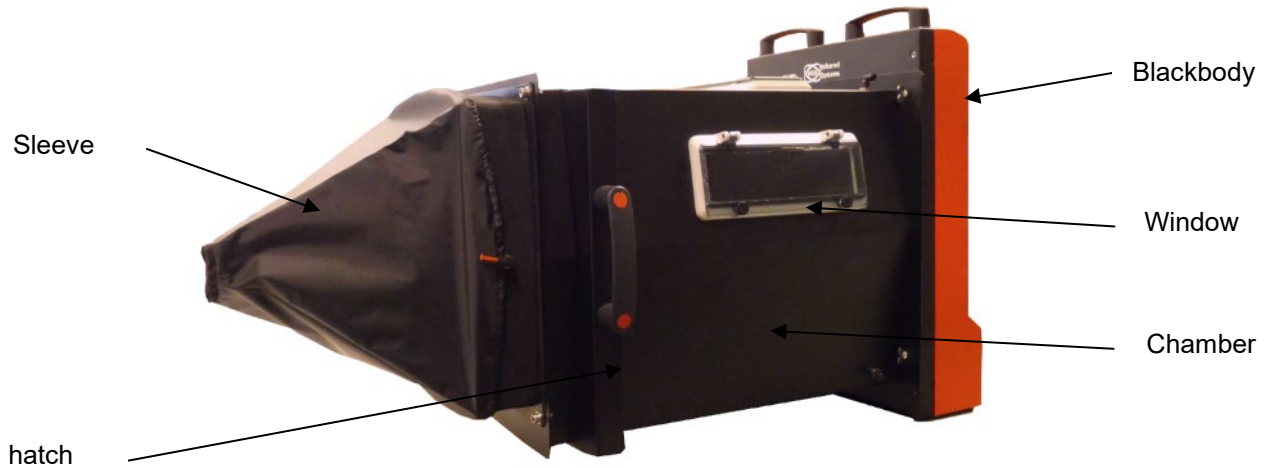

The system consists in four different parts:

- A chamber with four dry air inputs,
- A hatch,
- Desiccant box with the desiccant. Box must be open during the use, and desiccant must be unused and activated,
- A set of sleeves. The sleeves are fixed in front of the mechanical adaptor. The size of the sleeves depends on the lens diameter of the unit under test. The lens is fixed on the other side of the sleeve.



2.7. AIR DEFLECTORS (N7 and N12 only)

The blackbody can be mounted with deflectors to avoid air from the sides of the DCN1000 N7 or N12 to disturb other instruments.

The air deflectors can easily be removed. The presence or absence of air deflectors does not affect the blackbody operation.

Air deflectors are shown on Figure 1.

2.8. SUPPLY

The reference blackbody DCN 1000 and Twin1000 is delivered in one case including:

- Blackbody head with protective cover and Tamb cap (DCN1000 only),
- 2 air deflectors (DCN1000N7 and N12 only),
- Electronic controller,
- Electronic controller Main power cable,
- Head to electronic controller cable,
- A USB key including remote control software Infratest-LT, the operating manual of the communication protocols and this operating manual,
- A Quick Start Guide,
- Ethernet to PC cable,
- Calibration Certificate,
- Control sheet,
- HGH Declaration of Conformity.

In case of DCN 1000 L blackbody only and supplied into a separate case from the above:

- The thermostat,
- 2 insulated fluid pipes,
- Ethylene glycol jug,
- Thermostat user's manual.



2.9. OPTIONAL SUPPLIES

2.9.1. Target support (DCN1000 only)

Including target sensor.



Figure 20: DCN 1000 N7 with target support

2.9.2. Test targets (DCN1000 only)

- Mounted test targets,
- Numerous patterns available,
- Test targets certificate of conformity.



Figure 21: DCN 1000 H4 mounted with target holder and targets

2.9.3. Anti-condensation / Frost system (DCN1000 only)

- Mechanical adaptor or Dry box
- Set of sleeves (2 or 3 depending on the size),



- Desiccant box.

2.9.4. Additional head (DCN1000 size 2 to 4 only)

- Blackbody head with protective cover and Tamb cap
- Head to electronic controller cable,
- Calibration Certificate,
- Control sheet,
- HGHI Declaration of Conformity.

2.9.5. LabView drivers and/or SDK license

Included into the USB key and the associated operating manual.



3. OPERATION

3.1. PREPARATION OF THE BLACKBODY

First, keep the packaging used for sending the blackbody. It must be used if the blackbody is sent back to HGH for maintenance or calibration. If HGH Customer Support receives a blackbody not properly packed, cost of a new packaging may be charged at that time.

Before connection, check on the electronic controller that the power switch is *OFF*.

Use the handles to lift the Blackbody head. If necessary, handles can be removed using a M4 hexagonal male key.

Set the blackbody head on a stable surface. HGH recommends to fix it using the dedicated holes in its base plate.

Check that fans air inlets and outlets are not obstructed.

Check on the identification labels that both head and electronic controller have the same type (example: DCN 1000 H2). Never try to connect a head that has not the same type as the Electronic controller.

Correctly connect the cables in the following order:

High voltage, do not put your fingers into the connectors.

1. Connect the Tamb cap or the target (wheel) sensor cable (option),
2. If necessary, connect the Ethernet communication cable (or RS232C or IEEE488),
3. Connect the blackbody head to controller cable (W01),
4. Check that mains terminals are equipped with **ground connectors**. Then check that the main supply is correct and connect the Electronic controller Main power cable.

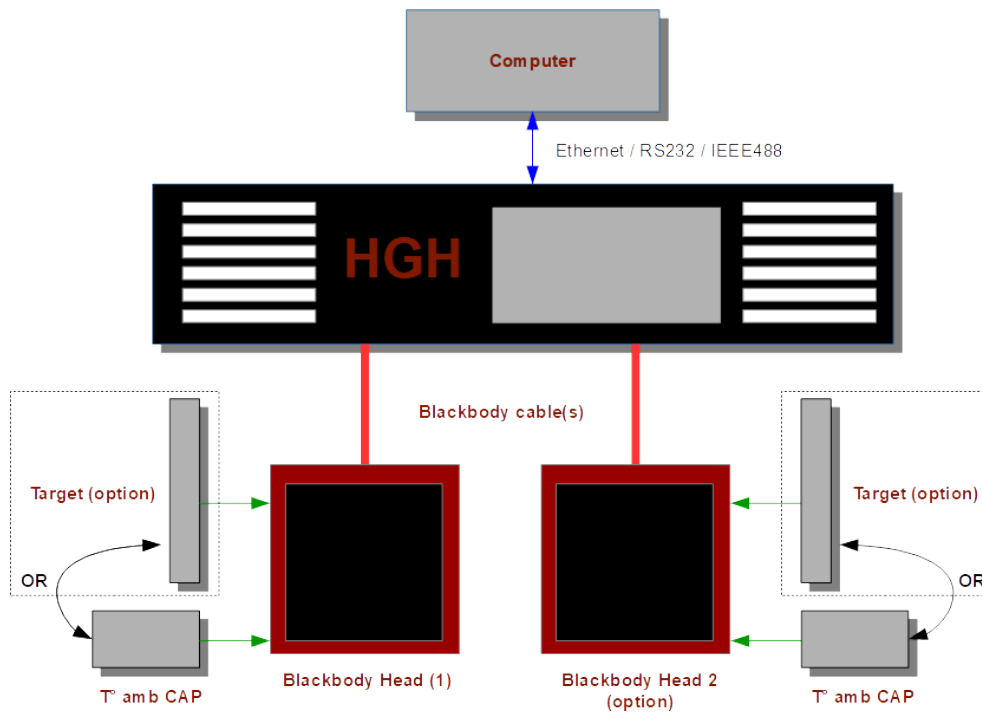

Figure 22: Interconnection diagram

Remove the protective cover and switch the POWER and MAINS buttons ON.

The main screen is then displayed. This is the screen on which the temperatures are displayed.

Check on the identification label on the head that its serial number is the same as written in the controller. To check the serial number written in the controller please refer to Figure 32: Selection screen (1/2). The number is written in front of the Blackbody type.



3.2. PREPARATION OF THE THERMOSTAT (DCN 1000 L ONLY)

3.2.1. Important remark regarding the temperature range of the DCN1000L blackbodies

The nominal temperature range of the DCN1000L blackbodies is [-40°C; 150°C] for a 20°C ± 5°C.

Thanks to its powerful thermal exchange capability toward the fluid, the DCN1000L can be operated outside this range under the following conditions:

- For low room temperatures below 0°C, down to -20°C and in case the DCN1000L is exceptionally operated down to -40°C (DCN1000W2L for example): the fluid circulation must imperatively be operated continuously even if the blackbody power is off.
- For high room temperatures up to 70°C (+85°C for the DCN1000W2L): the fluid circulation must also imperatively be operated continuously even if the blackbody power is off and the minimum achievable temperature on the blackbody surface cannot be lower than 70°C below the room temperature.

Example: if room temperature is 50°C, the minimum achievable setpoint on the blackbody surface is -20°C with recommended fluid temperature -20°C.

3.2.2. Fluid properties

The system is delivered with a jug of dedicated cryogenic fluid (Kryo 30 type). HGH recommends to use this cryogenic fluid only for Blackbody Temperatures below 0°C. For simplicity reasons HGH recommends to use water if the DCN1000L is to be used exclusively at Blackbody Temperatures above 0°C.

Important remark: the use of any other fluid than Kryo 30 (or equivalent ethylene-glycol mixture) or water is strictly forbidden. Warranty is void in case of use of any other fluid.

The fluid (cryogenic fluid or water) must be replaced every two months.



H302 Harmful if swallowed



H373 May cause damage to organs through prolonged or repeated exposure



Before processing, please read the thermostat user manual given with the thermostat.



Wear chemical splash goggles: in case of contact, immediately flush eyes of water at least 15 minutes. Get medical aid.

3.2.3. Getting started

Before the first use:

- Check no cap is plugged in the output of the thermostat,
- Connect the blackbody head and the thermostat thanks to the 2 insulated pipes. Avoid folding the pipes,
- Fill the thermostat tank. The fluid top level must be just above the cooling device (coil).

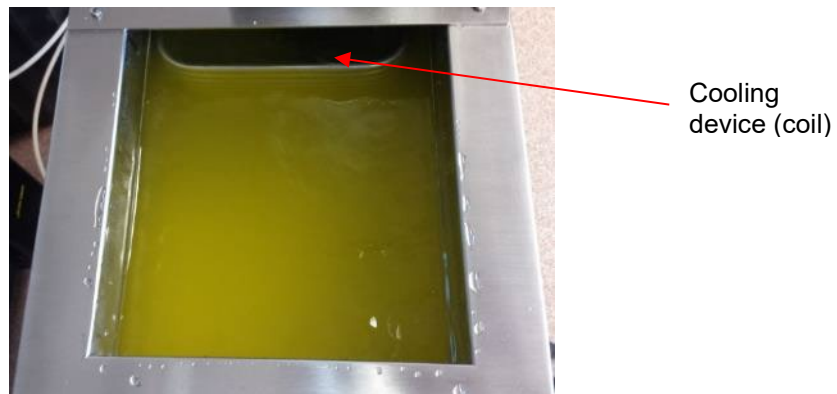

Figure 23 : fluid top level

- Plug in the thermostat.
- Switch on the thermostat thanks to the 0/1 button.
- Add fluid in the thermostat if it is necessary.

In case of questions, please refer to the Thermostat user's manual with the thermostat.

3.2.4. Starting the fluid temperature control

Switch on the thermostat thanks to the 0/1 button.

Click on *Thermostat* on the advanced menu to control the fluid temperature (refer to 3.6.7.6).

3.2.5. Important remarks for thermostat operation

Hereafter are some recommendations for the maintenance of the thermostat and its cooling fluid:

- Make sure that the chiller is ON before switching on the electronic controller of the blackbody.
- Raise the chiller off the ground to avoid the accumulation of dust on the ventilation modules of the chiller as much as possible. Don't hesitate to regularly blow compressed air inside the ventilated parts of the chiller in order to assure its efficiency.

3.2.6. Thermostat and fluid upkeep procedures

Replace the Kryo 30 fluid when it starts becoming brown. This is important in order to maintain a good thermal transfer.

Tank emptying procedure:

- Turn the electronic controller of the blackbody OFF,
- Turn off the refrigerated unit,
- Put an empty bucket or equivalent under the outflow valve,
- Unscrew the outflow valve screw so that the liquid spills inside the bucket,
- Raise the tubes in order to be sure there is no liquid remaining inside and that all the liquid is poured inside the tank,
- When the chiller tank is empty, screw the outflow valve screw before refilling with new fluid.
- Before replacing the fluid, clean first the tank:
 - o Rinse the inside of the fluid reservoir with water,
 - o Clean the inside with a sponge with white vinegar,
 - o Rinse again the fluid reservoir with water.

This procedure avoids accumulation of dirt and artefacts that can clog the fluid circulation of the chiller.

3.3. USE OF THE ANTI CONDENSATION /FROST SYSTEMS (DCN1000 only)

3.3.1. Desiccant activation



Figure 24 : Desiccant

- Place the desiccant (one layer thick) on a glass plate (for an activation in a microwave oven) or in a metallic plate (for an activation in a traditional oven).
- Activate the desiccant during 5 minutes in a microwave oven at high power or 2 – 3 hours in a traditional oven at 200°C.
- Store the desiccant in an airtight container. It can be used once it is cooled down.

3.3.2. Use of the set of sleeves (DCN1000 only)

3.3.2.1. Setting up

Assemble the mechanical adaptor in front of the blackbody thanks to 4 knobs.

Connect a $\varnothing 4$ mm rubber hose between the gas input (located on the mechanical adaptor) and a dry gas cylinder.

Place some activated desiccant in the mechanical adaptor.

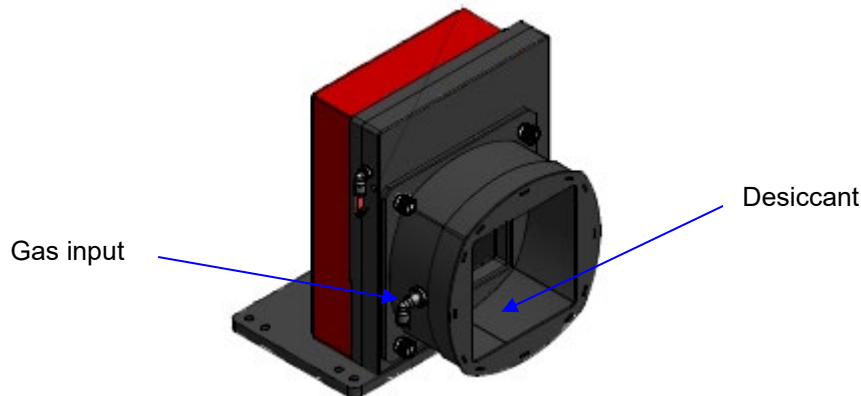

Figure 25 : Setting the mechanical adaptor

Fix the sleeve around the mechanical adaptor and around the lens of the system under test by tightening the thin cords.

3.3.2.2. Humidity removal

- Remove the sleeve. Set the blackbody temperature at 100°C (refer to paragraph 3.6). Keep the system in this configuration during at least 10 minutes.
- Fix the sleeve on the system under test and on the blackbody. Set the blackbody temperature at ambient temperature. When the blackbody temperature is under 50 °C, switch on the Dry Gas flow (1.5 bars).
- Set the blackbody temperature at the desired low temperature. Once the temperature is reached, wait 5 minutes. Frost may appear on the emissive area of the blackbody.
- Set the blackbody temperature at 20°C. Once the temperature is reached, wait for 1 minute.
- Set the blackbody temperature at 100°C. Once the temperature is reached, wait for 5 minutes.
- Set the blackbody temperature at ambient temperature. When the blackbody temperature is about 30 °C, set the blackbody temperature at the desired temperature.

3.3.2.3. During the DCN 1000 use

Switch on the Dry Gas flow (1.5 bar) and keep it in use during the measurement.

Notice:

- If the flow is too intense, there might be air turbulence that could induce the instability of the blackbody.
- If the flow is too weak, freeze may appear on the surface.



- You may find the right compromise.

3.3.3. Use of the dry box with sleeves (DCN1000 only)

3.3.3.1. Setting up

Attach the chamber on the front of the blackbody using the 4 locks.

Connect the 4 pipes to the 4 connections of the chamber. Connect the distributor to pressurized dry gas (nitrogen)

Put desiccant in the chamber in an open box.

Insert the hatch and close the chamber.

3.3.3.2. Humidity removal

See paragraph 3.3.2.2.

3.3.3.3. Use

Keep running the dry gas flow during the measurement.

Connect the sleeve to the optics of infrared sensor to be tested and tighten.

Open the hatch during the acquisition time and only during this time. Close the hatch as soon as the acquisition is done.

Important remark: If the hatch is open more than 2 minutes at -20°C, frost may appear. To remove it, follow the Humidity removal instruction (paragraph 3.3.2.2).

3.4. CONDENSATE WATER REMOVAL (DCN1000 only)

The DCN1000 blackbodies are all equipped with an output for condensate water on the surface.

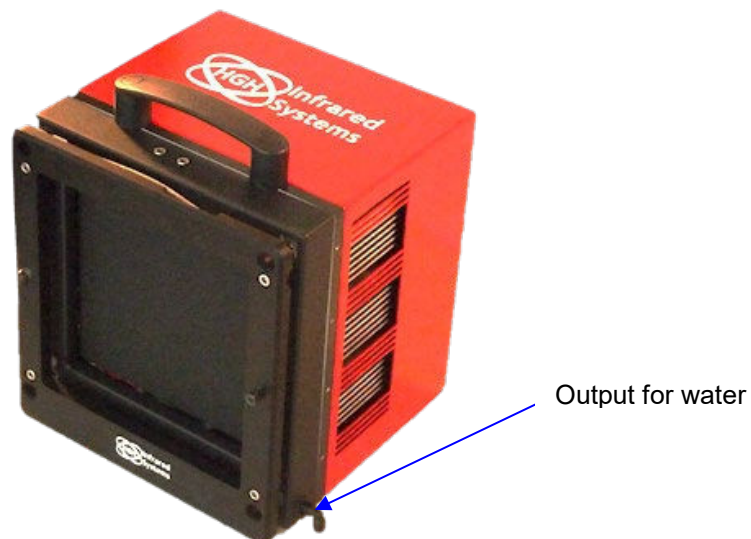

A 6 mm diameter pipe can be connected to this output to evacuate runoff water of the emissive surface.

Important remark: do not blow dry air through this output as it would destabilize the blackbody.



3.5. PREPARATION OF THE TARGET AND TARGET SUPPORT (DCN1000 only)

The target support is attached to the blackbody through the holes at each corner of the blackbody plate. The protective cover must be removed to attach this target support. A sensor is mounted in the target support. Connect the sensor to the Sub-D 9 contacts "TARGET SENSOR" connector (refer to Figure 9: Blackbody head connectors).

3.6. USER INTERFACE

3.6.1. Starting procedure

Switch on the power switch at the rear panel of the controller. The main button at the front panel of the controller becomes red. Then turn on this main button. During the starting procedure this button is blinking blue. This procedure may last a few seconds before the HGHI logo appears.

Some tests are set up in the controller. The result of these tests is displayed. Please refer to the Quick Start Sheet supplied with the blackbody or to the paragraph 5.5.2.

By validating the result screen, the main screen is displayed.

To ensure highest precision of the measurement of the temperature, the operator must wait for 20 minutes from the start-up of the controller to make sure thermal equilibrium of the electronic controller has been reached.

3.6.2. DCN 1000 – Main screen

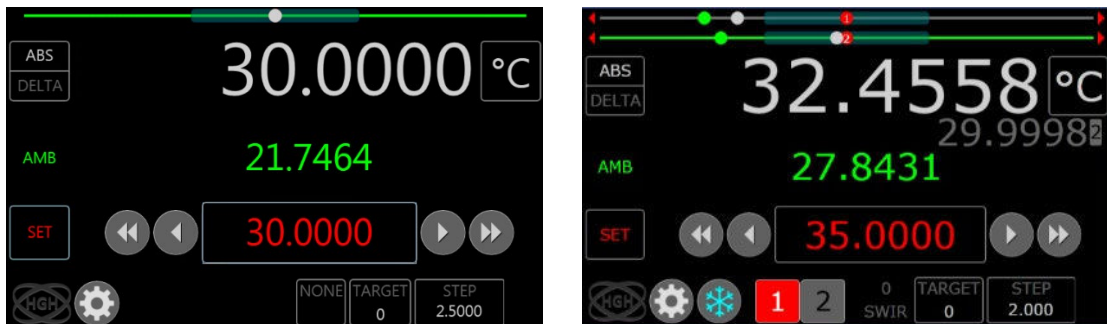

Figure 26 : Main screen, left: Single Blackbody configuration/ right: Double Blackbody configuration

3.6.2.1. General operation

The screen is a touch screen: areas with possible action are surrounded by a rectangle or a circle. This rule is applicable whatever the displayed page.

Examples:

- Actions possible:
- No action possible:

ABS or DELTA: indicates respectively the absolute temperature of the emissive surface or the temperature difference between the temperature of the emissive surface and the ambient/ target temperature. Press the button ABS or DELTA to switch from one mode to the other.



In case the user changes the mode, the applied set point is the last selected set point previously applied to this mode.

Current temperature is displayed in white in absolute mode and in yellow in differential mode.

AMB: indicates the ambient temperature. It is either the temperature of the front plate of the blackbody or the temperature of a remote target sensor connected to blackbody head. Ambient temperature is displayed in green.

Temperature set point (**30.0000** in red in the above example, left): indicates the current temperature set point, which is either the absolute temperature set point (in ABS mode) or the relative temperature set point (in DELTA mode). Press this button to get to set point modification keypad (refer to paragraph 3.6.4).

C : indicates if the temperature is displayed in °C, °F or K. Press the button to change the temperature unit.

SET : This button gives access to predefined set-points.



: This button gives access to protected parameters (administrator only) and user parameters.

TARGET : This button gives access to the screen in which the external target (option) can be selected.

STEP : Press this button to choose the value of the step between two set points.

◀ ▶ : Press these buttons to move on the previous or the next set point. The gap is the STEP value or ten times the STEP value ▶▶ ◀◀ .

The top line provides a graphical display of all temperature's status.

- : The temperature set point is characterized by the red dot. The green, yellow or white dot describes the status of the blackbody respectively for ambient, differential or absolute temperature. It appears in green when the temperature of the blackbody has reached the set point and is stabilized (blue area around the setpoint - these parameters of the stabilization indicator can be modified in the administrator menu, refer to paragraph **Erreur ! Source du renvoi introuvable.**). If the blackbody hasn't reached the set point yet the dot is white. It appears in yellow when the differential mode is selected.

3.6.2.2. Double blackbody head configuration

In the case where two heads are connected, some buttons are added and additional information are required to control them simultaneously.



1 **2** : This selector allows the selection of the blackbody to be controlled. The red button is the actual selected blackbody (eg: here is the Blackbody #1 selected).

29.9998² : This is a display information only; it shows the temperature of the non-selected emissive head following by its number (eg: here the Blackbody #2's surface is stabilized at 29.9998 °C).

 : There are two stability rod, each one is differentiated by the blackbody number (eg: the Blackbody #2 is stabilized while #1 is heating).

3.6.2.3. Double head special operation: blackbody 1 regulated versus blackbody 2

The double head configuration can be operated such that the blackbody 1 surface can be regulated in differential mode versus the target temperature (usual mode) or versus the absolute temperature of blackbody 2. In such a later case, the AMB temperature displayed in green is the absolute temperature of blackbody 2. The selection between target temperature and blackbody 2 as ambient (i.e. background) temperature is described into the Advanced menu (see paragraph 3.6.7.6).

Warning! The reciprocity is not possible. Blackbody 2 cannot be regulated in differential versus blackbody 1 absolute temperature.

The combination of the Blackbody 2 absolute setpoint and Blackbody 1 differential setpoint must not exceed the absolute temperature range of Blackbody 1. 2 examples:

- Blackbody 2 absolute setpoint = -10°C and Blackbody 1 differential setpoint = -15°C leads to Blackbody 1 equivalent absolute setpoint = -25°C: this configuration is not possible
- Blackbody 2 absolute setpoint = -10°C and Blackbody 1 differential setpoint = -3°C leads to Blackbody 1 equivalent absolute setpoint = -13°C: this configuration is possible

3.6.3. TwiN1000 – Main screen

The TwiN1000 configuration is the same as the two DCN1000 connected.

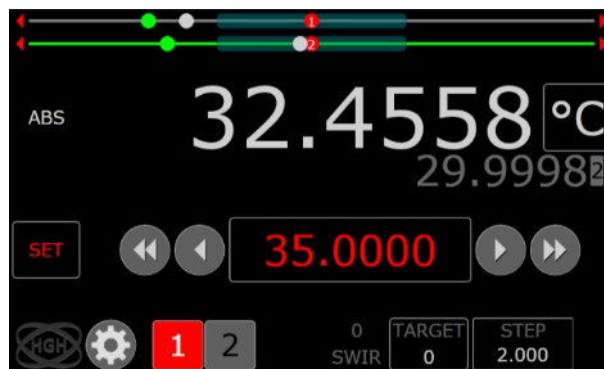

Figure 27: Twin1000 – Main screen

There are the same buttons:

- Arrow to move on the previous or the next set point,
- Protected parameters,
- Unit change,
- Temperature set point zone,



- Target,
- Set,
- Step,
- Selector to change the blackbody selected.

There is no ambient temperature in the TwiN1000 blackbody.

3.6.4. Numeric keypads



Figure 28: Numeric keypad

This screen is the numeric keypad that appears anytime the user presses a numerical value he wants to modify or the temperature set point button in the main screen. It allows entering a new value for the corresponding variable. When a new value is entered, the user must press to take it into account and then press Return () to get back to the screen from which the keypad was called. If different values can be changed in the same screen, press to get from one value to the next.

Press this button to suppress the previous variable.

Press these buttons to select any variable in the number.

Press the variable anywhere you want to set the cursor at this position.



Figure 29 : Letter keypad

This screen is the keypad that appears anytime the user presses a not-only numerical value like a password. When a new value is entered, the user must press to take it into account.

Press this button to suppress the previous variable.

Press the selected variable to set the cursor at this position.



3.6.5. Target selection menu

Click on the *TARGET* button of the main screen to get to this screen.

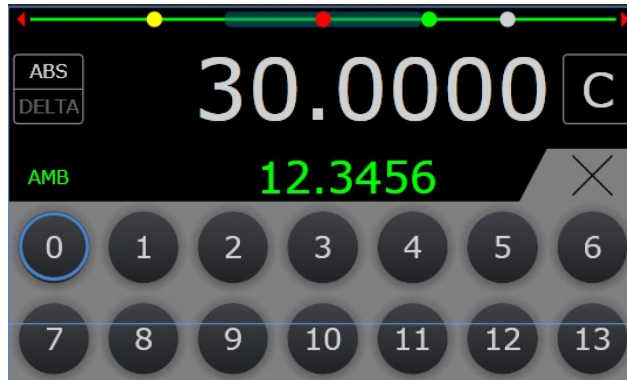

The number of the currently selected target is displayed (target 0 in the above example).

Important remark: By default, the target number 0 corresponds to the sensor placed in the Tamb cap. When a remote target is connected to the blackbody head, the target number parameter must be changed in accordance to the effective target number. This procedure ensures a correct temperature reading.

Click on the number of the target to modify this parameter. Close the menu. The target number must have changed in the target button.

3.6.6. Predefined set-points

In this screen, there are predefined temperature set points that can be chosen by the user instead of entering them manually from the main screen. Its purpose is to make it faster and more convenient for the user to select the temperature set points that he often uses.



Figure 31 : Predefined temperature table

The different predefined temperature set points can be changed by the user:

Press  to select the temperature set-points. Press one of these temperatures to change the temperature set point to the corresponding value. In this example, the current mode is ABS, so for instance, pressing a temperature changes the absolute temperature set point from 30.000°C to the value on the button.



Remark: the set point values of the table can be applied either to absolute or to differential mode.

Warning: it is not possible to change from one mode to the other from this screen; it must be done from the main screen.

Press **X** to get back to the main screen.

3.6.7. Advanced menu

This menu gives access to protected parameters such as calibration parameters. Some can't be modified (user menu), some can be modified by an advanced customer administrator, others are factory parameters and only HGH has an access to them.



Click on the  button of the main screen to get to the administrator selection screen:

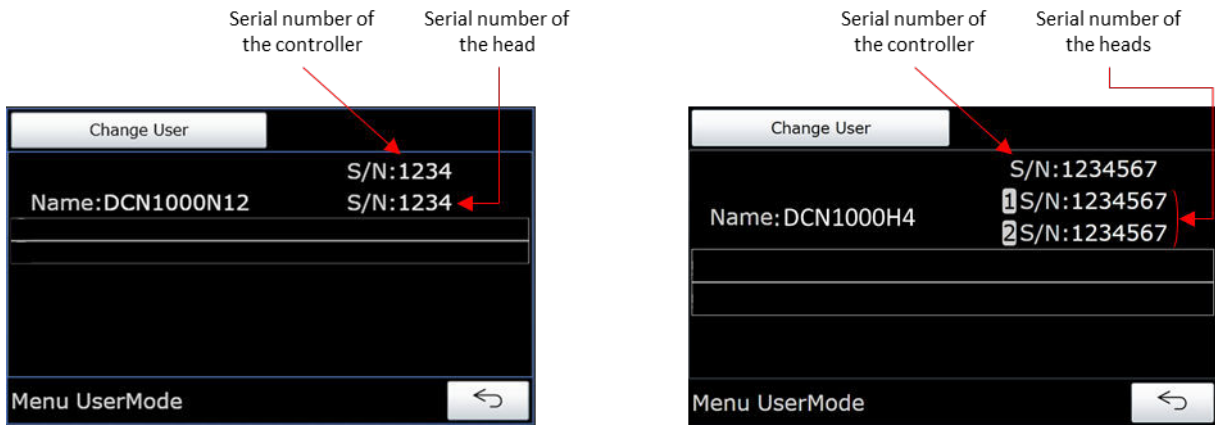

Figure 32: Selection screen (1/2), left: 1 head connected / right: 2 heads connected

TwIN1000 exception: heads 1 and 2 of course have the same serial numbers.

The menu by default is the user menu. To switch on Advanced menu, click on *Change User* to display the following screen.

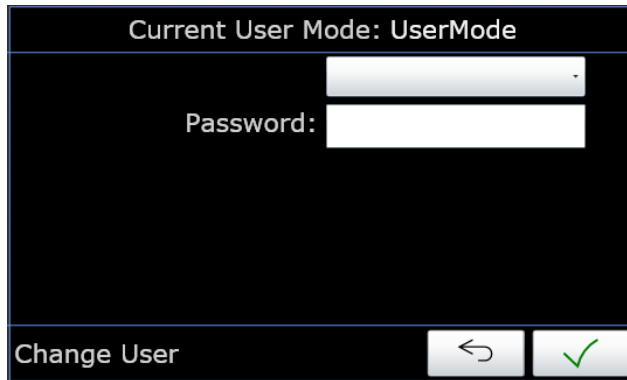

Figure 33: Selection screen (2/2)

Choose Advanced in the drop menu. Then enter the customer password using the numeric keypad. The Advanced password is provided in the control sheet of the blackbody.

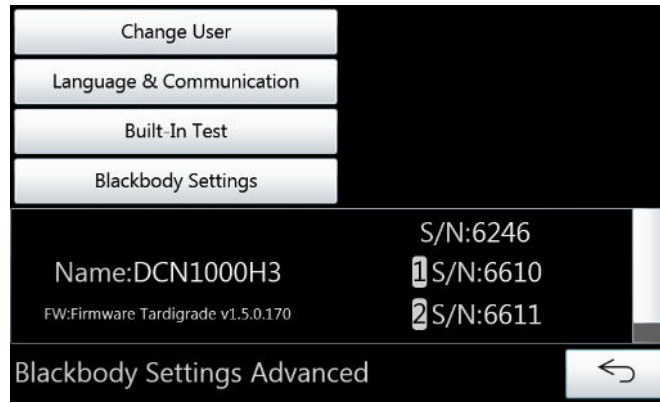

Figure 34: Customer advanced menu screen

3.6.7.1. Language & communication menu

Click on *Language & Communication* on the advanced menu to display the following screen.

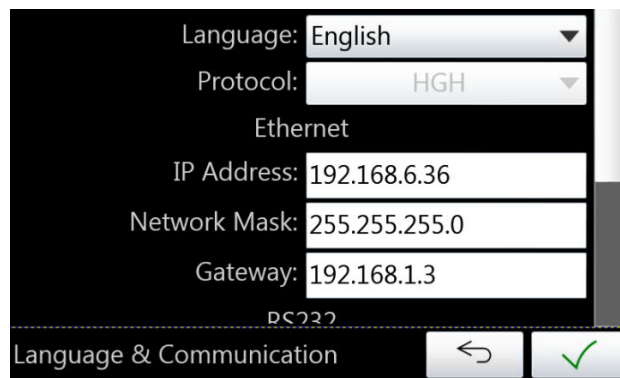

Figure 35: Language & Communication menu

Language: Choose the operation language of the controller (English or French).

Protocol is the communication protocol of the controller.

Ethernet, RS232, GPIB are the configurations of each remote control interface.

Default values are described in paragraph 4.



3.6.7.2. Built-In Test menu

See paragraph 3.3.2.2.

3.6.7.3. Blackbody Settings

The Blackbody Settings button leads to a menu dedicated to blackbody thermal parameters adjustment menus.

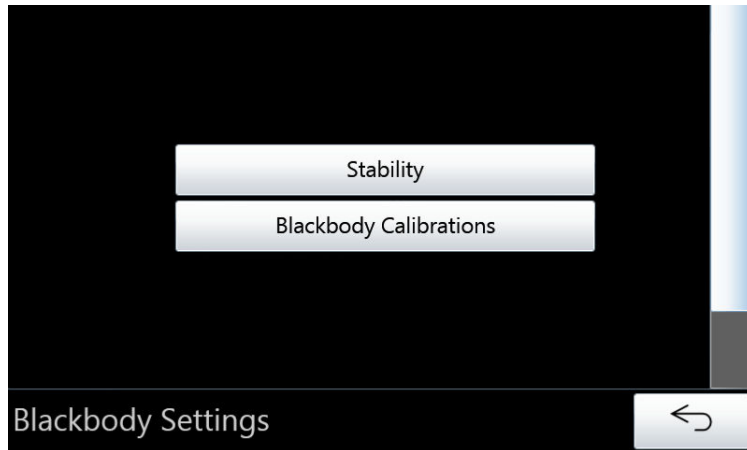

Figure 36 : Blackbody settings menu

3.6.7.4. Stability menu

Click on *Stability* on the Blackbody Settings menu to display the following screen:

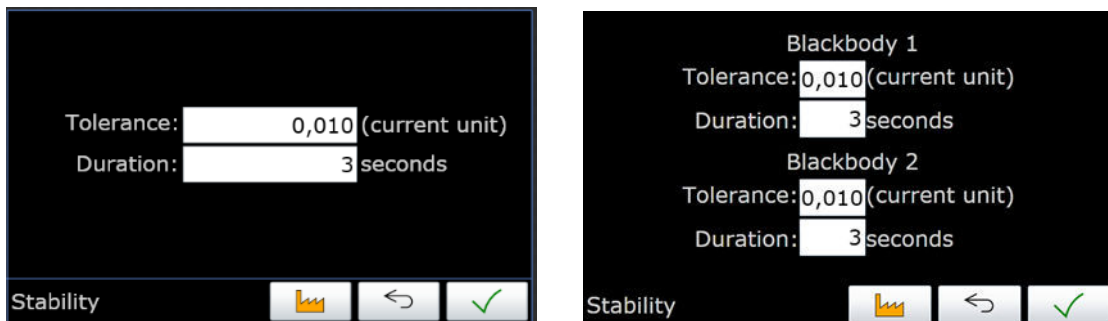

Figure 37: Stabilization menu screen, left: 1 head connected / right: 2 heads connected

This menu allows modifying the stabilization criteria.

Tolerance is the temperature tolerance (in °C) into which the blackbody is considered as stabilized.

Duration is the time in seconds during which the temperature error needs to be into the tolerance range so that the blackbody is considered as stabilized.

In the case both criteria are satisfied the circle at the top of the main screen becomes green and remains in the blue area stabilization.

Default values are dependent on the type of blackbody.



: Press this button to validate the new parameters and get back to the advanced menu.



: Press this button to get back to the advanced menu.



 : Press this button to get back to the default values.

3.6.7.5. Blackbody Calibrations menu

Click on *Blackbody Calibrations* on the Blackbody Settings menu to display the following screen.

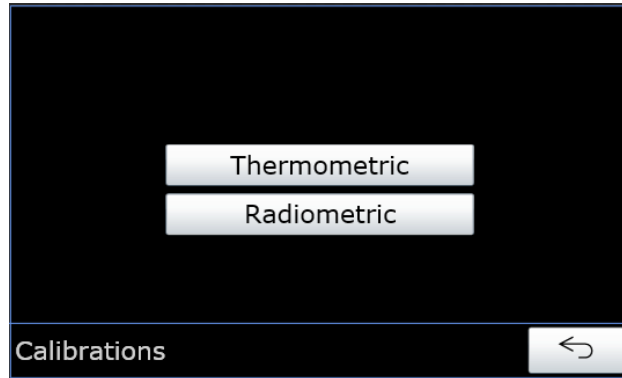

Figure 38: Main calibration menu

3.6.7.5.1. Thermometric calibration menu

Do not modify the TSES (Emissive Surface Temperature Sensor) sensor parameters without HGH recommendation.

3.6.7.5.2. Radiometric calibration menu

Click on **Radiometric** on the calibration menu to display the following screen.

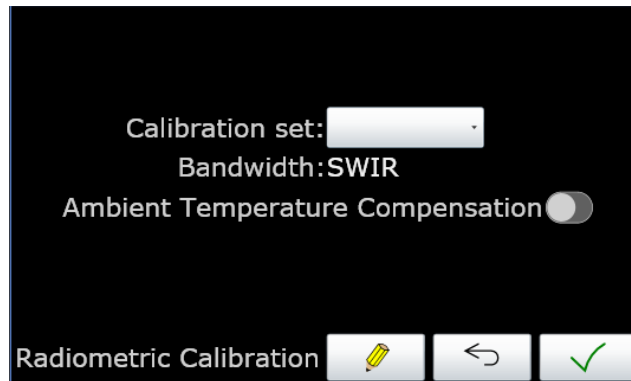

Figure 39 : radiometric calibration menu

This menu gives access to compensation parameters so that the actual radiance temperature equals the displayed temperature.

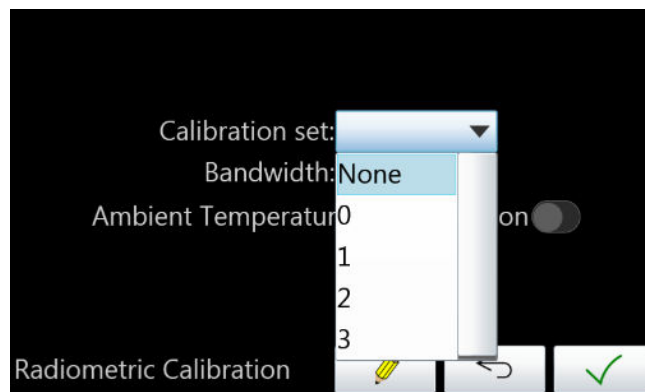

Figure 40 : Compensation set selection



On the drop menu choose the compensation set. The following choices are possible:

None: no compensation set

0: MWIR spectral bandwidth radiance temperature compensation set

1: LWIR spectral bandwidth radiance temperature compensation set

2 and 3 are remained free for complementary tables.

When **None** is selected, the displayed temperature is the physical temperature of the emissive surface. Actual emissivity of the emissive surface must be taken into account in order to calculate the radiance of the source.

Alternatively, the radiance can be calculated using the actual radiated temperature and emissivity value 1. The actual radiated temperature vs. displayed temperature table is shown on the delivered calibration certificate before compensation.

Displayed temperature / <i>Température affichée</i> (°C)	Real temperature of the source under test / <i>Température réelle de la source à étalonner</i> (°C)
0	0,88
20	20,02
50	49,39
110	109,04
150	149,26

Figure 41: Example: displayed temperature vs. actual radiated temperature with no compensation

Important remark: the actual radiated temperature depends on the spectral band. Make sure to select the correct table on the document.

In order to avoid this complex calculation, the selection of one of the available compensation sets allows to have:

$$\text{Displayed temperature} = \text{Radiated temperature}$$

Thus, the source behaves like a perfect blackbody over the selected spectral bandwidth. The selected bandwidth is written below the calibration set.

HGH blackbodies are delivered with 2 compensation tables: MWIR and LWIR. By default, the LWIR table is selected upon delivery. The selected table is shown on the main menu screen (see Figure 26).

Displayed temperature / <i>Température affichée</i> (°C)	Real temperature of the source under test / <i>Température réelle de la source à étalonner</i> (°C)
0	0,00
20	19,96
50	49,98
110	110,04
150	149,97

Figure 42: Example: displayed temperature vs. actual radiated temperature with compensation



Important remarks:

- HGH radiometric calibration results are traceable to International Primary Standard.
- The validity of this calibration cannot exceed 2 years. When the calibration has expired, the built-in test screen (see Figure 51), displayed when the controller is turn on, shows an error on the calibration date line.
- The calibration results are valid only at room temperature noted into the certificate $\pm 2^{\circ}\text{C}$ (see next paragraph).

3.6.7.5.3. Automated room temperature compensation

Each calibration set is calculated at the room temperature noted into the certificate $\pm 2^{\circ}\text{C}$. If the room temperature during the tests is different, the compensation sets are not applicable and radiance temperature might be different from the displayed temperature. To correct it, activate Ambient temperature compensation (see Figure 39).

For more information about the automated ambient temperature compensation function, refer to HGH website technical paper section.

Important remark: this function uses the temperature given by the Tamb cap or the target holder sensor as ambient temperature. Make sure this value represents the actual room temperature. If not, replaces the Tamb cap by a remote external sensor (option).

3.6.7.6. Background temperature selection (Double head configuration only)

The double head configuration allows the operator to define the blackbody n° 2 absolute temperature as the Background temperature and to regulate the Blackbody n° 1 in differential versus this background temperature. This function is particularly useful in case of using reflective targets.

In case of double head configuration, the Blackbody Settings menu looks different:

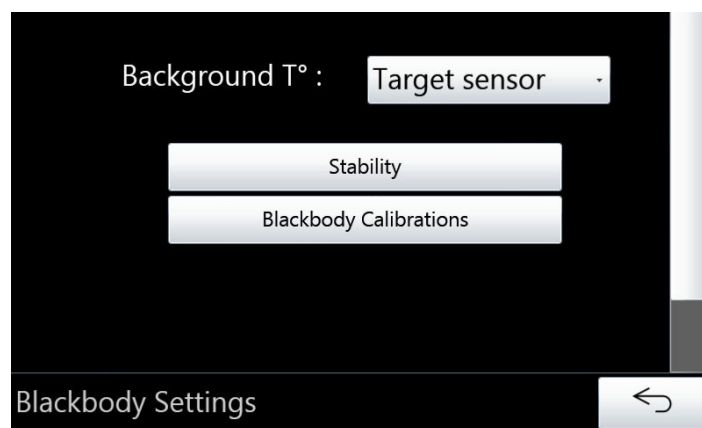

Figure 43: Blackbody settings menu – Double head configuration

Click on Background T° arrow to select between Target sensor and Blackbody 2 absolute temperature.

Warning: default selection is Target sensor.

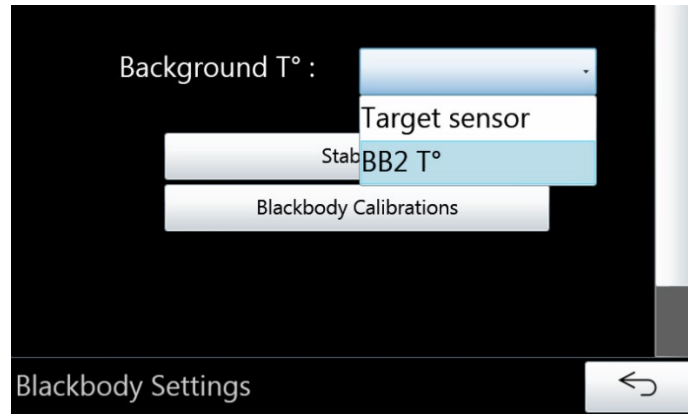

Figure 44 : Background temperature selection

Important remark: the reverse configuration (BB n°2 regulated vs. BB n°1) is not possible. The Background blackbody must be Blackbody n° 2.

3.6.7.7. Thermostat temperature selection (DCN 1000 L only)

The bath temperature is selected from the blackbody controller. No need to use the thermostat controller.



Figure 45: Thermostat temperature selection

3.6.7.7.1. Manual mode

Click on the Thermostat button  on the main screen to display the following screen.

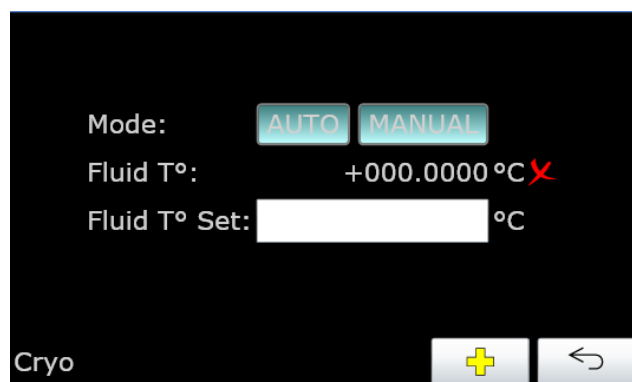

Figure 46: Thermostat menu

By default, when the electronic controller is switched on, the control mode is Manual.



Press the thermostat set point to change the value. The current temperature of the bath is displayed above the temperature set point.

A green mark appears once the bath temperature is stabilized.

To enhance the blackbody operation, HGHI recommends to set the same setpoint value for the blackbody and the fluid temperature, whenever this setting is possible. However, the bath temperature is limited between -25°C and $+60^{\circ}\text{C}$, whereas the blackbody absolute temperature is between -40°C and $+150^{\circ}\text{C}$. Figure 47 shows the recommended fluid temperature vs. blackbody set point temperature.

Do not intend to set the thermostat bath temperature outside the $[-25^{\circ}\text{C}; 60^{\circ}\text{C}]$ range.

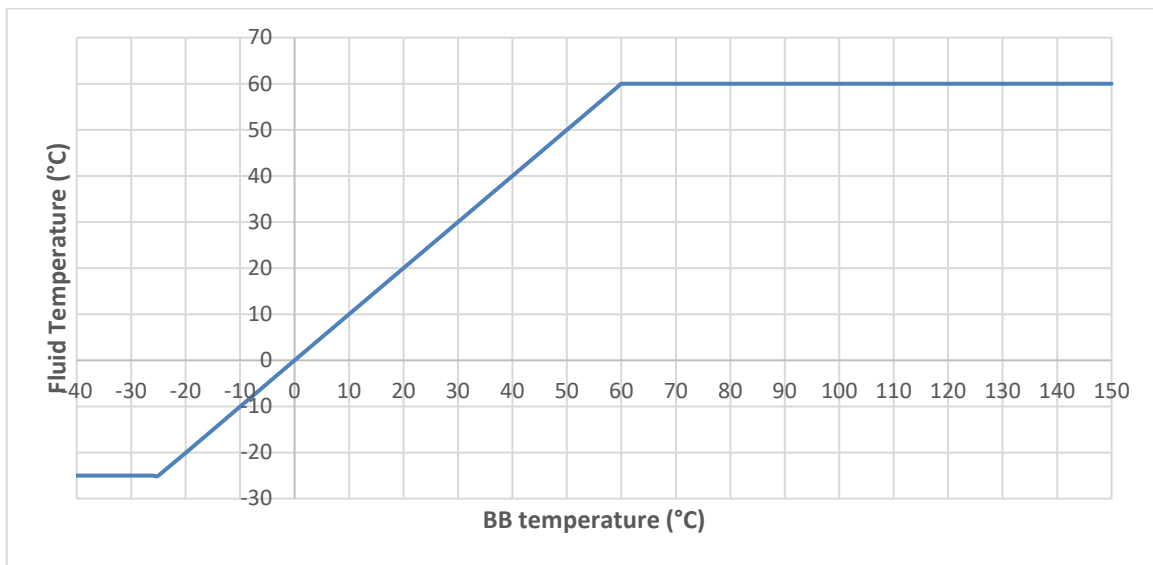

Figure 47: Fluid temperature vs. blackbody temperature

In case the user selects a temperature over 70°C , the thermostat activates its overheat protection.

Note: In the case the operator wants to reduce the temperature set-point significantly (more than -30°C , for instance from 50°C to -20°C), HGHI recommends to shut down the blackbody output power (with Infratest-LT software) till the difference between the thermostat set-point and its current value is less than -20°C .

3.6.7.7.2. Automatic mode

Click on automatic mode in the thermostat menu.

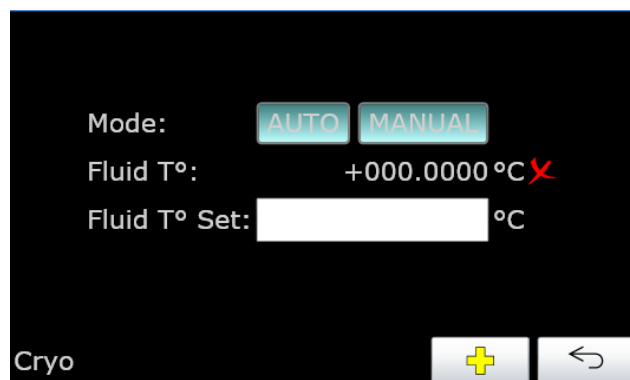

Figure 48: Thermostat menu

Modifying the bath temperature set point is then no longer possible.



The bath temperature now only depends on the blackbody temperature set point.



: Press this button to display the following details about the automatic mode.

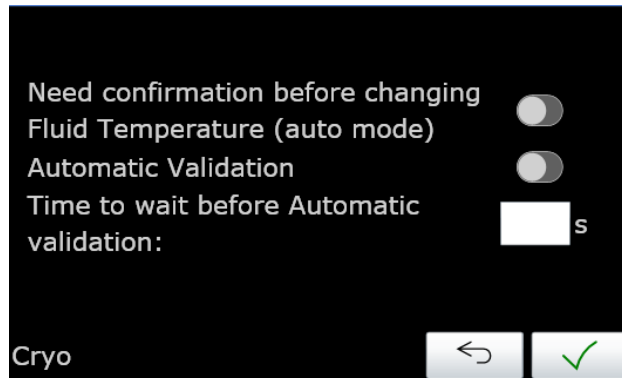

Figure 49 : Automatic mode parameters

Need confirmation: Display a confirmation before changing bath temperature. Thus, the user can prevent the bath temperature from changing automatically. HGH recommends to avoid the setpoint to depart from more than $\pm 10^{\circ}\text{C}$ from the fluid temperature.

Automatic validation: Automatically accepts the temperature change after *Time* seconds.

3.7. DCN 1000 LT (OPTION)

3.7.1. Special recommendations for operation

DCN 1000 LT are blackbodies compatible with wide environment range such as climatic chamber operation. The range of use of DCN 1000 LT is $[-55^{\circ}\text{C}; 85^{\circ}\text{C}]$.

HGH recommends to start tests at high ambient temperature and then set the climatic chamber temperature at lower temperatures (down to -55°C), rather than directly turning the blackbody on when the climatic chamber is under 0°C .

When the climatic chamber is heating, make sure the blackbody setpoint remains higher than the climatic chamber temperature to avoid condensation on the blackbody head. If not possible, set the blackbody temperature 30°C above the dew point during 30 minutes after climatic chamber temperature stabilization in order to remove residual humidity from the head.

Please make sure the blackbody head does not remain below dew point over long periods.

3.7.2. Blackbody temperature achievable range

The minimum and maximum achievable temperatures on the emissive surface depends on the environment temperature and are shown on the below Figure 50.

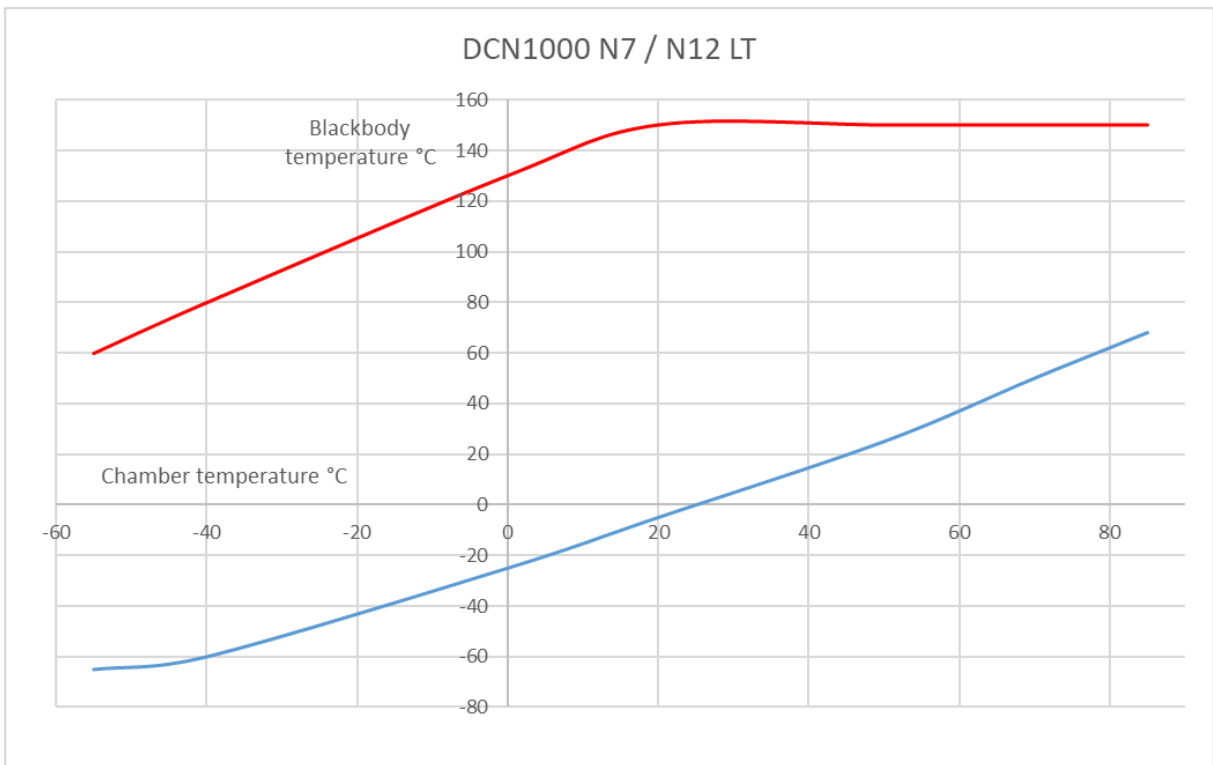
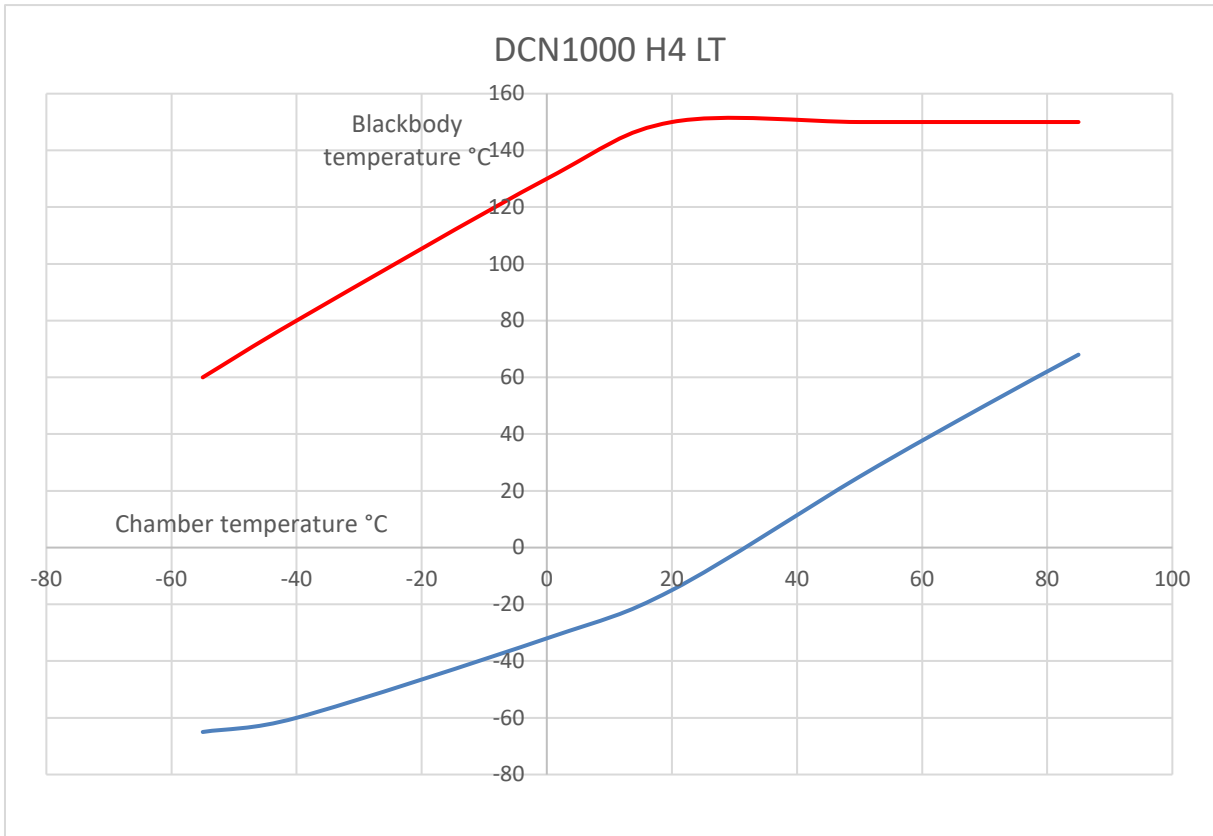

Figure 50: Achievable temperature range vs. chamber temperature



4. REMOTE CONTROL

The remote communication with HGH's blackbody is available through several communication links:

- Ethernet,
- RS232,
- IEEE488.

Ethernet, RS232 and IEEE488 protocols are available through the DOC058 Blackbody communication protocol delivered with the blackbody. Moreover, a dedicated remote control freeware Infratest-LT is available for Ethernet, IEEE488 and RS232 links. Please refer to the Infratest-LT user manual to configure and use your blackbody using one of these communication links.

LabVIEW drivers are also available for Ethernet, RS232 and IEEE488 communication links.

4.1. ETHERNET INTERFACE

Ethernet interface enables to connect several blackbodies on a network and to control them from a distant PC.

The blackbody is delivered with IP address **192.168.1.201**. You can change this IP address using INFRATEST – LT or through the touch screen via the Language & Communication menu.

4.2. RS232C INTERFACE

RS232C interface enables to connect one controller and to control it from a distant PC.

The freeware INFRATEST - LT is available to configure and control the blackbody using RS232 interface.

The blackbody is delivered with baud rate = 9600, parity = none, stop bit = 1, bit number = 8 and flow control = none. You can change these parameters using INFRATEST – LT or through the touch screen via the Language & Communication menu.

4.3. IEEE488 INTERFACE

IEEE488 interface enables to connect one controller and to control it from a distant PC.

The configuration of the converter is the following;

- IEEE address: default 10,
- IEEE configuration: no SRQ,
- Mode: device,

The address by default is 10. It is accessible in the Language & Communication menu. In the case Infratest software is used, make sure the NI IEEE488.2 drivers are installed.

4.4. LABVIEW DRIVERS (OPTION)

These LabVIEW drivers of the blackbody are compatible with LabVIEW v8 or higher and for all available communication links Ethernet, RS232 and IEEE.

The supply includes all the required VIs directly available from the LabVIEW menu. These functions allow the operator to send a temperature setpoint, read the current temperature, check the stabilization status and many other functions. It also includes an example program built from all the available VIs.

Refer to dedicated LabVIEW drivers operating manual for further information.



4.5. SDK LICENSE (OPTION)

The SDK license allows the operator to send a temperature setpoint, read the current temperature, check the stabilization status and many other functions.

Supported operating systems:	Windows 10, Windows 11
Operating environment:	.Net Framework 4.7.2
Development environment:	Visual Studio 2022
Development language:	C#
Supported platforms:	X64, x86, AnyCPU

The supply also includes an example program.



5. PRECAUTIONS OF USE AND MAINTENANCE

5.1. ELECTRONIC CONTROLLER

High voltage, do not put your fingers into the connectors.

Connect the Electronic controller on mains plug equipped with a **ground** terminal.

Control the correct connection of the connectors on back panels.

Do not cover the aeration holes.

Clean the controller with a humid soft cloth. Do not use solvent or alcohol.

Do not press the touch switches of the screen with a force greater than 30N.

Do not use benzene, paint thinner or other volatile solvents and do not use chemically treated cloths to clean the screen.

Never try to open the Electronic controller without HGH advice.

5.2. BLACKBODY HEAD



Danger OF COLD OR HEAT BURN

Avoid shocks to protect the thermoelectric elements.

Do not touch the emissive surface of the blackbody otherwise its emissivity could be seriously damaged.

Do not spray any paint or any other product on the emissive surface as it would damage its optical properties.

Remove dust with dry compressed air only.

Do not cover aeration holes.

Condensation or ice on the emissive surface causes damages on the emissivity. It is recommended to avoid maintaining the blackbody at low temperature.

Clean the blackbody's head with a humid soft cloth. Do not use solvent.

Install the protective cover, check that no condensation water remains, in case of storage or if the blackbody is unused for a long time.

5.3. COOLING FLUID

Before processing, please read the thermostat user manual given with the thermostat.



Wear chemical splash goggles: in case of contact, immediately flush eyes of water at least 15 minutes. Get medical aid.

The cooling fluid is very specific; do not try to replace it by a different one.



It is expensive, so it is preferable not to throw it away during maintenance but to refill a dedicated jug.

Do not refill the provided pure ethylene glycol jug as the thermostat tank contains a mixture

5.4. TEST TARGETS AND TARGET WHEEL (options)

Avoid any contact with the test targets to protect the coated surface.

A still atmosphere, without disturbance or draught, around the blackbody and the test target will ensure a good thermal stability.

5.5. TROUBLE SHOOTING

5.5.1. The main button remains off

When the user switches ON the power switch, a red light appears around the main button. If not, the controller may be misconnecting from the main supply. Press the main button. If nothing happens, the system remains silent and the screen off, check that the mains line is correctly 230V powered. Try again.

If the light indicator still remains off, please contact HGH.

5.5.2. Autotest

Startup and continuous tests are set up in the controller. Press the *Built-in-test* button in the Advanced menu to display the following screen.

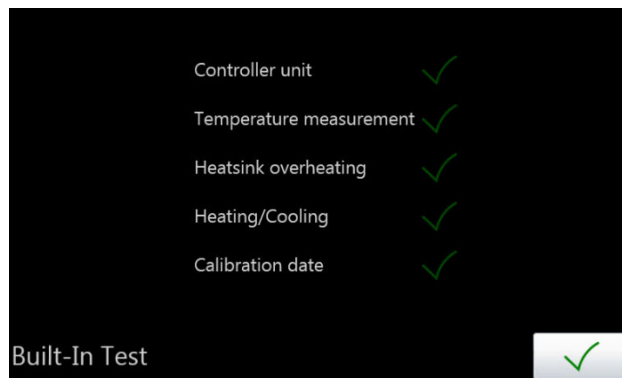

Figure 51 : Built-in-test result

If one of the 5 criteria is false (X instead of ✓), press + to show the following screen

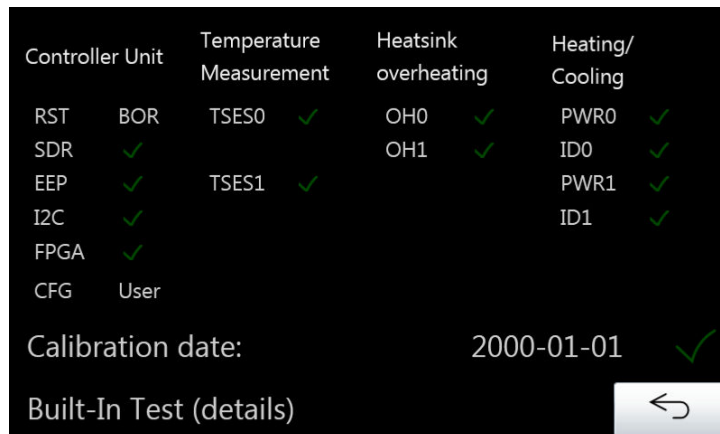

Figure 52: Built-in-test advanced menu



Controller unit:

- If an error appears on this part, turn the blackbody off and on. If the error remains, please contact HGH.

Temperature measurement: Sensor failure (Emissive Surface Temperature Sensor (TSES) or Ambient Temperature Sensor (TSA)).

- Check that the blackbody cable (between the Electronic controller and the head) W01 is correctly connected. Try again. If the error remains, please contact HGH.

Heatsink overheating:

- Check that the fans are working, and that the fans inlets and outlets are not obstructed. Try again. If the error remains, please contact HGH.

Heating/cooling:

PWRO: Power failure

- Check that the blackbody cable (between the Electronic controller and the head) W01 is correctly connected. Try again. If the error remains, please contact HGH.

ID0: Wrong head connected. If so, please connect the good head.

5.5.3. The fans don't work

The blackbody surface temperature is higher than 85°C and the fans of the head do not rotate.

- Check that the blackbody cable (between the Electronic controller and the head) W01 is correctly connected. Try again.
- Switch OFF the Electronic controller. Unplug the blackbody cable W01.
- Use an ohmmeter to measure the resistance between pin n°1 and pin n°10 on the blackbody connector of the head (Refer to Figure 9: Blackbody head connectors). If the resistance is more than 1kΩ, the fans might be damaged.

Otherwise, the controller might be faulty. Please contact HGH.

5.5.4. Inactive touchscreen

You switched on the controller and its touch screen remains inactive, it remains empty or the display is fixed, the measured temperatures don't change.

- The touchscreen communication may be interrupted. Switch OFF and ON the controller, then the operation may be normal.

The measured temperatures display seems to be normal but when you touch the screen it doesn't react.

- The touch screen may be locked. Actually, the touch screen can be locked by INFRATEST - LT through the computer interface. You can unlock the touch screen through the same interface (refer to INFRATEST - LT manual). Anyway, if you switch OFF then ON the controller, the touch screen will be unlocked.



5.5.5. Limited temperature range

You tried to set an extreme value in the specified working range but the blackbody temperature changes but can't reach this value.

- Check that the blackbody head is in a quiet environment protected from wind.
- The temperature ranges are given for a 20°C ambient temperature (refer to paragraph 6.2). For instance:
 - If the ambient temperature is 10°C the blackbody possibly can't reach T_{abs_max} value.
 - If the ambient temperature is 30°C the blackbody possibly can't reach T_{abs_min} value.

After having checked that the working conditions are consistent with the specified ones, if the temperature range is still limited, the power system needs re-adjustment or the thermoelectric elements might be deteriorated, please contact HGH.

5.5.6. The blackbody is unstable

You switched on the blackbody and set a temperature; the blackbody reaches the temperature but the stability is not good.

- Check that the blackbody head is in a quiet environment protected from wind.
- Check that the cables are correctly plugged and locked.
- Check that cables path is not near from a powerful electromagnetic emitter (unprotected electronic device).
- Check that ground is effectively connected to the controller.
- For perturbed atmospheric conditions (climatic chambers with circulating air), HGH offers different solutions like shelters or lens to blackbody head sleeve interface. Please contact HGH.

5.5.7. The thermostat displays an alarm message

- An overheat alarm displays : “ttt” .
- A low level alarm displays : “LLL”

An overheat alarm appears in the case the bath temperature is out of the allowed range. Switch OFF the Blackbody Controller.

Check on the display screen that the bath temperature is between the possible set-points: [-25°C; 60°C].

Then switch OFF and ON the thermostat, the alarm may disappear.

If the alarm message is still displayed, the thermostat may be faulty, please call HGH.

A low level alarm appears in the case the fluid level in the bath is too low. Switch OFF the Blackbody Controller.

Check the fluid level is 25mm below the bath cover.

Switch OFF the Thermostat.



If the level is low, fill the tank.

Switch ON the thermostat, the alarm may have disappeared.

Otherwise call HGH.

5.5.8. Blackbody shut down recommendations

In order to maintain at best the paint on the blackbody plate, it is recommended to input a blackbody temperature superior to the ambient temperature in which the blackbody is placed before switching off the blackbody.

For example, if the blackbody is in a room where it is 25°C ambient temperature, it's recommended to put the blackbody temperature at 50°C.

This avoids to have ice or condensation on the plate when switching off the blackbody.



6. MAIN CHARACTERISTICS

6.1. CONDITIONS OF USE

6.1.1. Electronic controller

PARAMETER		RANGE OF REFERENCE	RANGE OF USE	RANGE OF STOCKING
Climatic conditions	Ambient temperature	20°C ± 5°C	+5°C to +45°C	-20°C/+70°C
	Relative humidity without condensation	45% to 75%	20% to 80% (70% at 45°C)	10% to 80%

	RANGE OF REFERENCE	RANGE OF USE
DCN 1000 H2	100 to 250 VAC – 50 Hz or 60 Hz	90 VAC to 260 VAC – 45 Hz to 65 Hz
DCN 1000 W2		
DCN 1000 H3		
DCN 1000 H4		
DCN 1000 N7		
DCN 1000 N12		
DCN 1000 L4		
DCN 1000 L7		
DCN 1000 L12		
Twin 1000 CN		
Twin 1000 CF		
DCN 1000 N7 LT	220 to 250 VAC – 50 Hz or 60 Hz	200 to 260 VAC – 45 Hz to 65 Hz
DCN 1000 N12 LT		

Warning : the main cable supplied with DCN 1000 N7 LT or DCN 1000 N12 LT might not be compatible with the available 220 to 250 VAC wall socket. This main cable can be then replaced by a compatible cable: this replacement does not modify the warranty on the blackbody.



6.1.2. Blackbody head

PARAMETER		RANGE OF REFERENCE	RANGE OF USE	RANGE OF STOCKING
Climatic conditions	Ambient temperature	20°C ± 5°C	Type N/H : -20°C to +70°C LT option: -55°C to +85°C Type W: 5°C to 70°C Type L : -25°C to +70°C TwiN1000: -20°C to +70°C	Type N/H : -20°C to +70°C LT option: -55°C to 85°C Type W: 5°C to 70°C Type L : -25°C to +70°C TwiN1000: -20°C to +70°C
	Relative humidity without condensation	45% to 75%	20% to 80% (70% at 45°C)	10% to 80%

6.1.3. Thermostat (DCN 1000 type L only)

PARAMETER		RANGE OF REFERENCE	RANGE OF USE	RANGE OF STOCKING
Climatic conditions	Ambient temperature	20°C ± 5°C	+5°C to +40°C	0°C/+50°C
	Relative humidity without condensation	45% to 75%	20% to 80% (70% at 45°C)	10% to 80%
Supply	Mains voltage	230VAC ± 1%	208 to 250 VAC	-
	Frequency	50Hz or 60 Hz ¹	45Hz to 55Hz or 55Hz to 65Hz ¹	-

¹Main supply frequency must be specified upon purchase order.

6.2. MAIN SPECIFICATIONS

6.2.1. Mechanical characteristics

6.2.1.1. Electronic controller

- Description: 2U rack case, 19 inches (84 F) according CEI 297.3
- Dimensions: H 85 x L 450 x P 412 mm with 19" fixation braces.
- Weight: 6.5 kg (size 2 to 4) / 8.5 kg (size 7 and 12 or double head)
- Waterproofness: IP 20 according CEI 529

6.2.1.2. Blackbody head

Dimensions: Please contact HGHI to receive drawings and STEP documents.

Minimum radius of curvature of cables: R = 110 mm



6.2.1.3. Targets in mount (option for DCN1000 only)

Directly mounted on the Target support (option)

Refer to the target technical data sheet provided by HGH.

6.2.1.4. Functional characteristics

Temperature measurement:

- 2 inputs for Pt sensor, 4 wires (compensation of the resistance of the wires).
Linearization according to EIT 90 ().
- measurement current: 1 mA
- resolution: 0.0001°C

Temperature measurement incertitude:

- in absolute mode: $\pm 0.03^{\circ}\text{C}$ at 0°C and $\pm 0.05^{\circ}\text{C}$ at 100°C
- in differential mode: $\pm 0.01^{\circ}\text{C}$

Resolution of the absolute and differential temperature set points: $\pm 0.0001^{\circ}\text{C}$

Regulation: PID type

Temperature measurement: Pt sensor 100 at 0°C qualified class A according CEI 751 (NFC 42330), calibrated sensor

Protection of the Electronic controller:

- Protected with 2 delayed fuses: 6.3 A, 5 x 20mm glass cartridge
- Suppressor: according to VDE 0871-A

6.2.2. Test targets (options for DCN1000 only)

- Temperature measurement: Pt sensor 100 Ω at 0°C qualified class A according CEI 751, calibrated sensor.



DCN 1000 Type	Unit	H2	H3	H4	N7	N12	L4	L7	L12	Twin 1000 CN	Twin 1000 CF		
Heating slew rate	°C/s	Between 0.4 and 0.5 depending on Blackbody type and options.											
Cooling slew rate	°C/s	Between 0.2 and 0.3 depending on Blackbody type and options.											
Stabilization time at 2 mK	s	< 30											
Thermal uniformity at 50°C	°C RMS	0.1		0.2		0.1		0.15		0.1			
Thermal uniformity for -5°C < ΔT < +5°C	°C RMS	< 0.01											
Long term thermal stability at 20°C:	mK RMS	5											
Emissivity	-	0.98 ± 0.02 (Option 0.99 ± 0.01)											
Power supply (controller)	W	800			1600		800	1600		1000			
Power supply (refrigerated unit)	W	-					2300	2500	3800	-			
Minimum temperature	°C	-15			-5		-40			10	-5		
Maximum temperature	°C	150										90	150
Area size (square)	mm	50	75	100	180	300	100	180	300	42 (2 areas)			



7. Appendix 1

Platinum resistance thermosensors 100 Ω at 0°C

Table of relation between resistance and temperature, based on the following interpolation functions given by EIT 90:

$$- \quad t \text{ in } ^\circ\text{C} \in [0^\circ\text{C}, 850^\circ\text{C}] \quad R(t) = R(0^\circ\text{C}) \times (1 + A \times t + B \times t^2) \quad \text{in } \Omega$$

$$- \quad t \text{ in } ^\circ\text{C} \in [-200^\circ\text{C}, 0^\circ\text{C}] \quad R(t) = R(0^\circ\text{C}) \times (1 + A \times t + B \times t^2 + C \times t^3 \times (t - 100^\circ\text{C})) \quad \text{in } \Omega$$

With:

$$R(0^\circ\text{C}) = 100\Omega$$

$$A = 3.9083 \times 10^{-3} \text{ } ^\circ\text{C}^{-1}$$

$$B = -5.775 \times 10^{-7} \text{ } ^\circ\text{C}^{-2}$$

$$C = -4.183 \times 10^{-12} \text{ } ^\circ\text{C}^{-4}$$

Real resistance values are taken into account as calibration parameters to compensate the error due to the sensor accuracy.